

# CapeScint<sup>TM</sup>

Standard and Custom Radiation Detectors

## PRODUCT CATALOG

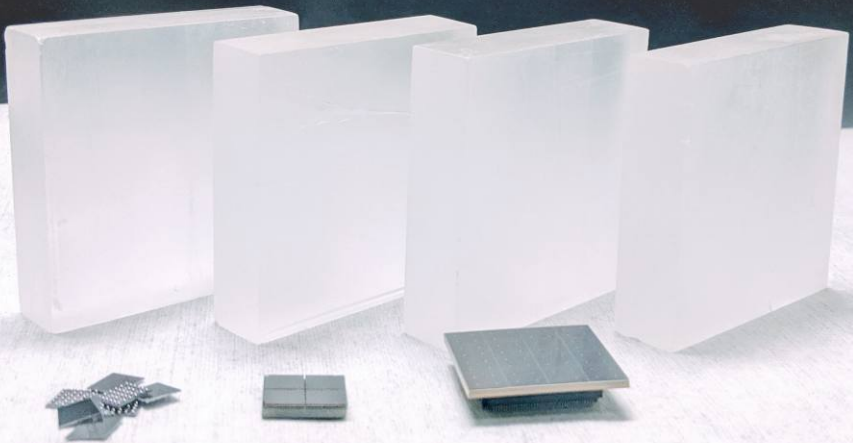

[capesint.com](http://capesint.com)

# CapeScint<sup>TM</sup>

## Standard and Custom Radiation Detectors



Scintillation  
Crystals



Detector  
Assemblies



Scintillation  
Probes

ABOUT	3
<hr/>	
SCINTILLATION CRYSTALS	4
ScintiClear Crystals	4
NaI(Tl) Crystals	7
CsI(Tl) Crystals	9
ElpasoLight Crystals	11
Typical Crystals 2D drawings	14
<hr/>	
SCINTILLATION ASSEMBLIES	18
ScintiClear Detector Assemblies	18
NaI(Tl) Detector Assemblies	23
CsI(Tl) Detector Assemblies	25
ElpasoLight Detector Assemblies	27
Typical Detector Assemblies 2D drawings	31
<hr/>	
SCINTILLATION PROBES	38
MacroPixel-MCA Spectrometric Gamma and Gamma Neutron Radiation Probes	38
MegaPixel-MCA Spectrometric Gamma and Gamma Neutron Radiation Probes	39
BDKG-05S Spectrometric Gamma Radiation Probe	40
NaI(Tl) Spectrometric Gamma Radiation Probes	41
NaI(Tl) High Sensitivity Spectrometric Gamma Radiation Probes	43

# CapeScint<sup>TM</sup>

Standard and Custom Radiation Detectors



CapeScint is a subsidiary of CapeSym, Inc. a multi-faceted company with 100+ years of combined experience in scintillators, semiconductors, and radiation detection instruments. CapeScint has its warehouse facilities and customer support staff located in Greater Boston Area, Massachusetts, USA.

Founded in 1992 as Cape Simulations, CapeSym, Inc. is now a multi-faceted company offering novel technical crystals and detectors for nuclear detection, including ScintiClear<sup>TM</sup> SrI<sub>2</sub>(Eu) and Elpasolight<sup>TM</sup> CLYC(Ce) scintillators. In addition, CapeSym offers SYMMIC thermal analysis software, materials characterization, and engineering consulting services.



Our ongoing R&D leverages decades of experience in crystal growth, solid state physics, analytical chemistry, materials science, thermo-fluid transport, and engineering design. CapeScint as a subsidiary of CapeSym, Inc. has a long history working with the US Government as a contractor and as a supplier of essential goods and services. During the last 30 years CapeSym, Inc. and supported missions of multiple US Government agencies including NASA, MDA, USAF, DoE, DTRA, NIH, CWMD, and US Navy.

CapeScint is an authorized reseller of ATOMTEX radiation measurement products. ATOMTEX produces more than 100 different nuclear instrumentation products, sold world-wide in 120 countries.





Each radiation detection probe offered by CapeScint undergoes a wide range of laboratory tests and calibration routines to ensure high quality metrological and performance characteristics.



## ScintiClear Crystals



CapeSym's **ScintiClear™** is a new high-performance  $\text{SrI}_2(\text{Eu})$ -based scintillator made in the USA. A proprietary crystal growth process improves its inherently excellent properties and limits the negative effects of Eu self-absorption. Guaranteed energy resolution of ScintiClear sensors is  $\leq 3.3\%$  at 662 keV. With 4.6 g/cc density,  $Z_{\text{eff}} = 49$ , and emission peaking at 430nm ScintiClear sensors are an excellent choice for all kind of applications.

- Extremely high light output 90,000 ph/MeV
- Energy resolution near 3% at 662 keV
- High density 4.6 g/cc and high effective atomic number
- Custom shapes and encapsulation configurations are available upon request

	SC-25x2	SC-51x2	SC-25x25
Shape	Cylinder	Cylinder	Cylinder
Detector type	$\text{SrI}_2(\text{Eu})$	$\text{SrI}_2(\text{Eu})$	$\text{SrI}_2(\text{Eu})$
Detector size	Ø25.4x2 mm	Ø50.8x2 mm	Ø25.4x25.4 mm
Energy range	From 2 keV	From 2 keV	From 15 keV
Typical resolution	30% at 5.9 keV	30% at 5.9 keV	3.2% at 662 keV
Typical sensitivity to gamma radiation, cps/( $\mu\text{Sv}\cdot\text{h}^{-1}$ )	NA ( $^{137}\text{Cs}$ ) NA ( $^{60}\text{Co}$ )	NA ( $^{137}\text{Cs}$ ) NA ( $^{60}\text{Co}$ )	260 ( $^{137}\text{Cs}$ )
Dimensions	Ø30x7 mm	Ø57x7 mm	Ø32x32 mm
Weight	12 g	48 g	80 g
Additional Information	0.1mm Be window for low energy X-rays	0.1mm Be window for low energy X-rays	Encapsulated in 1mm thick Al canister with a quartz window
Image			

## ScintiClear Crystals

	<b>SC-25x38</b>	<b>SC-38x38</b>	<b>SC-40x40</b>
Shape	Cylinder	Cylinder	Cylinder
Detector type	SrI <sub>2</sub> (Eu)	SrI <sub>2</sub> (Eu)	SrI <sub>2</sub> (Eu)
Detector size	Ø25.4x38.1 mm	Ø38.1x38.1 mm	Ø40.0x40.0 mm
Energy range	From 15 keV	From 15 keV	From 15 keV
Typical resolution	3.2% at 662 keV	3% at 662 keV	3% at 662 keV
Typical sensitivity to gamma radiation, cps/(µSv·h <sup>-1</sup> )	390 ( <sup>137</sup> Cs)	750 ( <sup>137</sup> Cs) 590 ( <sup>60</sup> Co)	850 ( <sup>137</sup> Cs) 760 ( <sup>60</sup> Co)
Dimensions	Ø32x45 mm	Ø46x46 mm	Ø46x46 mm
Weight	110 g	240 g	275 g
Additional Information	Encapsulated in 1mm thick Al canister with a quartz window	Encapsulated in 1mm thick Al canister with a quartz window	Encapsulated in 1mm thick Al canister with a quartz window
Image			

	<b>SC-51x51</b>	<b>SC-63x63-G</b>	<b>SC-76x76</b>
Shape	Cylinder	Cylinder	Cylinder
Detector type	SrI <sub>2</sub> (Eu)	SrI <sub>2</sub> (Eu)	SrI <sub>2</sub> (Eu)
Detector size	Ø50.8x50.8 mm	Ø63.5x63.5 mm	Ø76.2x76.2 mm
Energy range	From 15 keV	From 15 keV	From 15 keV
Typical resolution	3% at 662 keV	3% at 662 keV	3% at 662 keV
Typical sensitivity to gamma radiation, cps/(µSv·h <sup>-1</sup> )	1500 ( <sup>137</sup> Cs) 1200 ( <sup>60</sup> Co)	2500 ( <sup>137</sup> Cs) 2150 ( <sup>60</sup> Co)	3750 ( <sup>137</sup> Cs) 3350 ( <sup>60</sup> Co)
Dimensions	Ø59x58 mm	Ø71x72 mm	Ø86x84 mm
Weight	580 g	1050 g	1750 g
Additional Information	Encapsulated in 1mm thick Al canister with a quartz window	Encapsulated in 1.5mm thick Al canister with a quartz window	Encapsulated in 1.5mm thick Al canister with a quartz window
Image			

## Unambiguous Identification with ScintiClear

### Ba-133 radioactive source

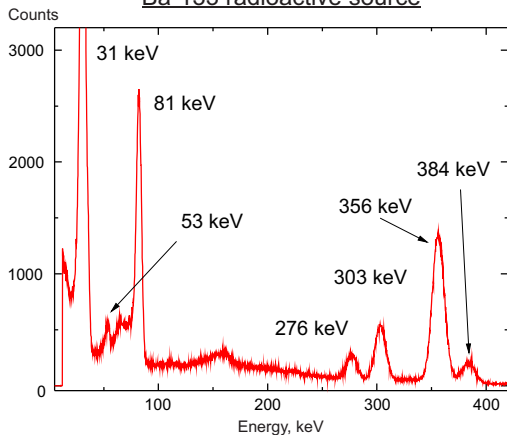

### U-ore environmental sample

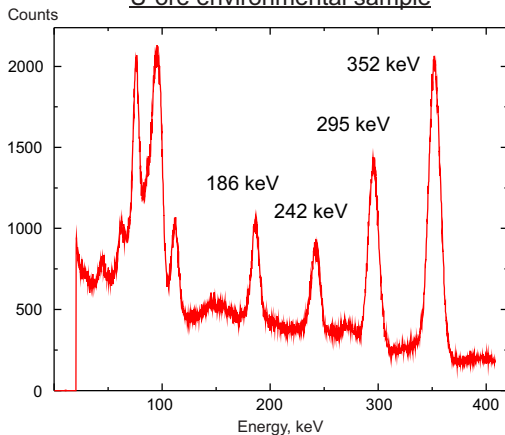

### U-ore environmental sample + Cs-137

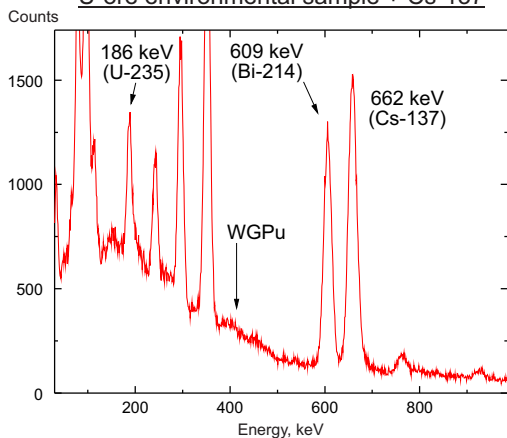

### U-ore environmental sample + Co-60

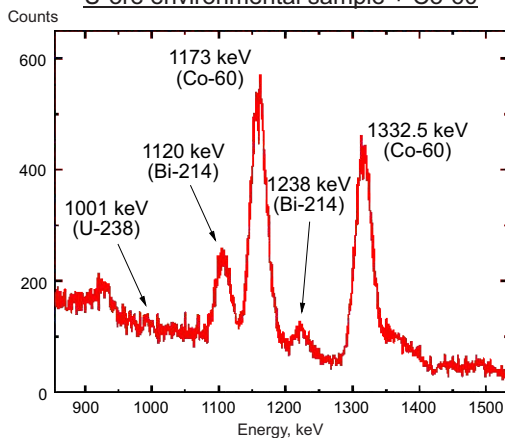

### Co-60 radioactive source

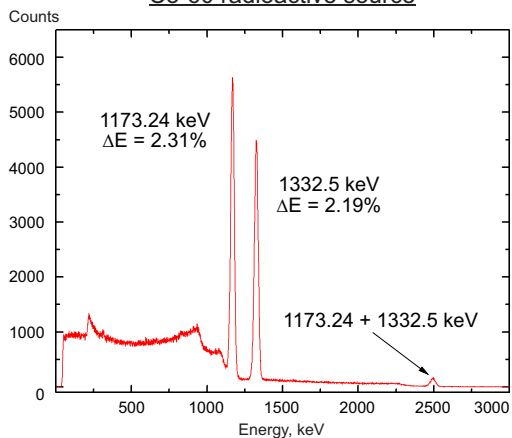



Critical situations demand immediate and accurate identification of the radiological material present. ScintiClear™ easily separates low energy <sup>133</sup>Ba peaks as well as the <sup>137</sup>Cs and <sup>134</sup>Cs lines (662 keV and 605 keV respectively) and eases the task of identifying the 186 keV line (HEU) and 414 keV line (WGPu) even in the presence of interfering radionuclides.

ScintiClear™ also offers high energy resolution in the MeV range, and no internal activity. These attributes, combined with good linearity, high density and Z<sub>eff</sub> enable clear identification of 1001 keV line (DU) and high energy environmental peaks.

## Nal(Tl) Crystals

Nal(Tl) inorganic scintillation crystals were discovered in 1948 and are up to date the best known and most widely used scintillators. Despite the large number of scintillating compounds only a few of them can compete with Nal(Tl) in terms of light output, energy resolution, and definitely price.



- Sizes of Nal(Tl) crystals up to 127 mm in diameter and 500 mm long are commercially available
- Light output 40,000 ph/MeV of gamma energy
- Energy resolution near 6.5% at 662 keV
- Custom configurations available upon request
- 100% of crystals are subject to quality control in the USA



	<b>Nal-25x25</b>	<b>Nal-25x38</b>	<b>Nal-38x38</b>
Shape	Cylinder	Cylinder	Cylinder
Detector type	Nal(Tl)	Nal(Tl)	Nal(Tl)
Detector size	Ø25.4x25.4 mm	Ø25.4x38.1 mm	Ø38.1x38.1 mm
Energy range	From 15 keV	From 15 keV	From 15 keV
Typical resolution	6.5% at 662 keV	6.5% at 662 keV	6.5% at 662 keV
Typical sensitivity to gamma radiation, cps/( $\mu\text{Sv}\cdot\text{h}^{-1}$ )	225 ( $^{137}\text{Cs}$ )	335 ( $^{137}\text{Cs}$ )	670 ( $^{137}\text{Cs}$ )
Dimensions	Ø32x32 mm	Ø32x45 mm	Ø46x46 mm
Weight	70 g	95 g	210 g
Additional Information	Encapsulated in 1mm thick Al canister with a quartz window	Encapsulated in 1mm thick Al canister with a quartz window	Encapsulated in 1mm thick Al canister with a quartz window
Image			



# Scintillation Crystals

## Nal(Tl) Crystals



	<b>Nal-40x40</b>	<b>Nal-51x51</b>
Shape	Cylinder	Cylinder
Detector type	Nal(Tl)	Nal(Tl)
Detector size	Ø40.0x40.0 mm	Ø50.8x50.8 mm
Energy range	From 15 keV	From 15 keV
Typical resolution	6.5% at 662 keV	6.5% at 662 keV
Typical sensitivity to gamma radiation, cps/( $\mu\text{Sv}\cdot\text{h}^{-1}$ )	750 ( $^{137}\text{Cs}$ )	1350 ( $^{137}\text{Cs}$ )
Dimensions	Ø46x46 mm	Ø59x58 mm
Weight	230 g	490 g
Additional Information	Encapsulated in 1mm thick Al canister with a quartz window	Encapsulated in 1mm thick Al canister with a quartz window
Image		

	<b>Nal-63x63-G</b>	<b>Nal-76x76</b>
Shape	Cylinder	Cylinder
Detector type	Nal(Tl)	Nal(Tl)
Detector size	Ø63.5x63.5 mm	Ø76.2x76.2 mm
Energy range	From 20 keV	From 15 keV
Typical resolution	6.5% at 662 keV	6.5% at 662 keV
Typical sensitivity to gamma radiation, cps/( $\mu\text{Sv}\cdot\text{h}^{-1}$ )	2000 ( $^{137}\text{Cs}$ )	3550 ( $^{137}\text{Cs}$ )
Dimensions	Ø71x72 mm	Ø86x84 mm
Weight	840 g	1450 g
Additional Information	Encapsulated in 1.5mm thick Al canister with a quartz window	Encapsulated in 1.5mm thick Al canister with a quartz window
Image		

## CsI(Tl) Crystals



CsI(Tl) inorganic scintillation crystals have moderate light output of 55,000 photons/MeV, primary decay time about 1000 ns, reasonable density of 4.51 g/cc, and peak emission wavelength about 550 nm. Cesium Iodide scintillators are only mildly hygroscopic and do not easily crack under stress.

- Sizes of CsI(Tl) crystals up to 127 mm in diameter and 500 mm long are commercially available
- Light output 55,000 ph/MeV of gamma energy
- Energy resolution near 6% at 662 keV
- Custom configurations available upon request
- 100% of crystals are subject to quality control in the USA

	<b>CsI-25x25</b>	<b>CsI-25x38</b>	<b>CsI-38x38</b>
Shape	Cylinder	Cylinder	Cylinder
Detector type	CsI(Tl)	CsI(Tl)	CsI(Tl)
Detector size	Ø25.4x25.4 mm	Ø25.4x38.1 mm	Ø38.1x38.1 mm
Energy range	From 15 keV	From 15 keV	From 15 keV
Typical resolution	6% at 662 keV	6% at 662 keV	6% at 662 keV
Typical sensitivity to gamma radiation, cps/( $\mu\text{Sv}\cdot\text{h}^{-1}$ )	260 ( $^{137}\text{Cs}$ )	390 ( $^{137}\text{Cs}$ )	750 ( $^{137}\text{Cs}$ ) 590 ( $^{60}\text{Co}$ )
Dimensions	Ø32x32 mm	Ø32x45 mm	Ø46x46 mm
Weight	80 g	110 g	240 g
Additional Information	Encapsulated in 1mm thick Al canister with a quartz window	Encapsulated in 1mm thick Al canister with a quartz window	Encapsulated in 1mm thick Al canister with a quartz window
Image			

# Scintillation Crystals



## CsI(Tl) Crystals

	<b>CsI-40x40</b>	<b>CsI-51x51</b>	<b>CsI-63x63</b>
Shape	Cylinder	Cylinder	Cylinder
Detector type	CsI(Tl)	CsI(Tl)	CsI(Tl)
Detector size	Ø40.0x40.0 mm	Ø50.8x50.8 mm	Ø63.5x63.5 mm
Energy range	From 15 keV	From 15 keV	From 20 keV
Typical resolution	6% at 662 keV	6% at 662 keV	6% at 662 keV
Typical sensitivity to gamma radiation, cps/( $\mu\text{Sv}\cdot\text{h}^{-1}$ )	850 ( $^{137}\text{Cs}$ ) 670 ( $^{60}\text{Co}$ )	1500 ( $^{137}\text{Cs}$ ) 1200 ( $^{60}\text{Co}$ )	2500 ( $^{137}\text{Cs}$ )
Dimensions	Ø46x46 mm	Ø59x58 mm	Ø71x72 mm
Weight	275 g	580 g	1050 g
Additional Information	Encapsulated in 1mm thick Al canister with a quartz window	Encapsulated in 1mm thick Al canister with a quartz window	Encapsulated in 1.5mm thick Al canister with a quartz window
Image			

## ElpasoLight Crystals



**ElpasoLight™** is a new material based on Ce-doped  $\text{Cs}_2\text{LiYCl}_6$  and is an excellent dual-mode neutron-gamma radiation sensitive scintillator. With a gamma energy resolution near 4%, a high cross-section for thermal neutrons, and excellent pulse shape discrimination (PSD) of 2.6, it is a promising replacement for medium resolution gamma-ray detectors and  $^3\text{He}$  tubes. These scintillators can also be enriched with  $^6\text{Li}$  or  $^7\text{Li}$  for adjusting thermal-neutron cross section.



- Sizes of ElpasoLight crystals up to  $\varnothing 76 \times 152$  mm ( $\varnothing 3 \times 6$ ") are commercially available (larger sizes can be manufactured upon request)
- Medium light output 20,000 ph/MeV of gamma energy and 70,000 ph/neutron
- Energy resolution near 4% at 662 keV
- High cross-section for thermal neutrons
- Custom shapes and encapsulation configurations are available upon request

	nEL-51x51x13	nEL-25x25	nEL-25x38
Shape	Cuboid	Cylinder	Cylinder
Detector type	$\text{Cs}_2\text{LiYCl}_6$	$\text{Cs}_2\text{LiYCl}_6$	$\text{Cs}_2\text{LiYCl}_6$
Detector size	50.8x50.8x12.7 mm	$\varnothing 25.4 \times 25.4$ mm	$\varnothing 25.4 \times 38.1$ mm
Energy range	From 15 keV	From 15 keV	From 15 keV
Typical resolution	4.5% at 662 keV	4.0% at 662 keV	4% at 662 keV
Typical sensitivity to gamma radiation, cps/ $(\mu\text{Sv}\cdot\text{h}^{-1})$	620 ( $^{137}\text{Cs}$ )	210 ( $^{137}\text{Cs}$ )	315 ( $^{137}\text{Cs}$ )
Neutron detection	Yes	Yes	Yes
Dimensions	56x56x19.5 mm	$\varnothing 32 \times 32$ mm	$\varnothing 32 \times 45$ mm
Weight	155 g	65 g	90 g
Additional Information	Optical window on the 50.8x50.8 mm face	Encapsulated in 1mm thick Al canister with a quartz window	Encapsulated in 1mm thick Al canister with a quartz window
Image			

# Scintillation Crystals



## Elpasolight Crystals

	nEL-38x38	nEL-40x40	nEL-51x51
Shape	Cylinder	Cylinder	Cylinder
Detector type	Cs <sub>2</sub> LiYCl <sub>6</sub>	Cs <sub>2</sub> LiYCl <sub>6</sub>	Cs <sub>2</sub> LiYCl <sub>6</sub>
Detector size	Ø38.1x38.1 mm	Ø40.0x40.0 mm	Ø50.8x50.8 mm
Energy range	From 15 keV	From 15 keV	From 15 keV
Typical resolution	4% at 662 keV	4.5% at 662 keV	4% at 662 keV
Typical sensitivity to gamma radiation, cps/(µSv·h <sup>-1</sup> )	620 ( <sup>137</sup> Cs)	715 ( <sup>137</sup> Cs)	1300 ( <sup>137</sup> Cs)
Neutron detection	Yes	Yes	Yes
Dimensions	Ø46x46 mm	Ø46x46 mm	Ø59x58 mm
Weight	190 g	210 g	450 g
Additional Information	Encapsulated in 1mm thick Al canister with a quartz window	Encapsulated in 1mm thick Al canister with a quartz window	Encapsulated in 1mm thick Al canister with a quartz window
Image			

	nEL-51x102	nEL-63x63-G
Shape	Cylinder	Cylinder
Detector type	Cs <sub>2</sub> LiYCl <sub>6</sub>	Cs <sub>2</sub> LiYCl <sub>6</sub>
Detector size	Ø50.8x101.6 mm	Ø63.5x63.5 mm
Energy range	From 15 keV	From 20 keV
Typical resolution	4.5% at 662 keV	4.5% at 662 keV
Typical sensitivity to gamma radiation, cps/(µSv·h <sup>-1</sup> )	2600 ( <sup>137</sup> Cs) 2100 ( <sup>60</sup> Co)	2200 ( <sup>137</sup> Cs)
Neutron detection	Yes	Yes
Dimensions	Ø59x110 mm	Ø71x72 mm
Weight	900 g	780 g
Additional Information	Encapsulated in 1mm thick Al canister with a quartz window	Encapsulated in 1.5 mm thick Al canister with a quartz window
Image		

*Design and specifications are subject to change without notice*

## ElpasoLight Crystals

	nEL-76x76	nEL-76x152
Shape	Cylinder	Cylinder
Detector type	Cs <sub>2</sub> LiYCl <sub>6</sub>	Cs <sub>2</sub> LiYCl <sub>6</sub>
Detector size	Ø76.2x76.2 mm	Ø76.2x152.4 mm
Energy range	From 15 keV	From 20 keV
Typical resolution	4% at 662 keV	4.5% at 662 keV
Typical sensitivity to gamma radiation, cps/(µSv·h <sup>-1</sup> )	3450 ( <sup>137</sup> Cs)	6900 ( <sup>137</sup> Cs) 6000 ( <sup>60</sup> Co)
Neutron detection	Yes	Yes
Dimensions	Ø86x84 mm	Ø86x170 mm
Weight	1300 g	2800 g
Additional Information	Encapsulated in 1.5 mm thick Al canister with a quartz window	Encapsulated in 1.5 mm thick Al canister with a quartz window
Image		

## Typical Crystals 2D drawings

### Scintillation crystal **SC-25x2**

Dimensions:  $\varnothing 30 \times 7$  mm

Weight: 12 g

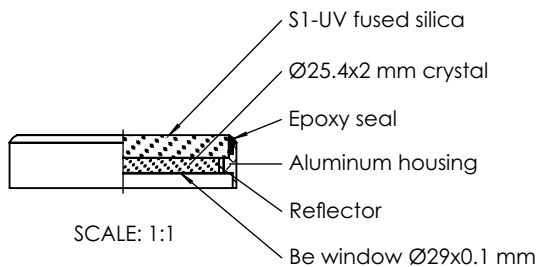

### Scintillation crystal **SC-51x2**

Dimensions:  $\varnothing 57 \times 7$  mm

Weight: 48 g

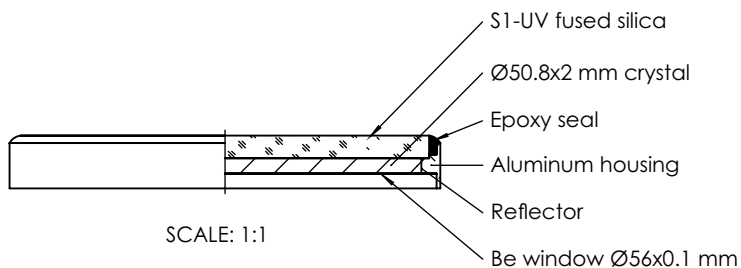

### Scintillation crystal **nEL-51x51x13**

Dimensions:  $\square 56 \times 19.5$  mm

Weight: 48 g

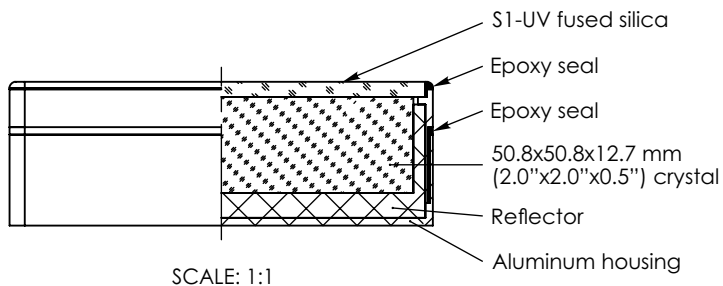

## Typical Crystals 2D drawings

### Scintillation crystal **SC-25x25**

Dimensions: Ø32x32 mm, Weight: 80 g

### Scintillation crystal **NaI-25x25**

Dimensions: Ø32x32 mm, Weight: 70 g

### Scintillation crystal **CsI-25x25**

Dimensions: Ø32x32 mm, Weight: 80 g

### Scintillation crystal **nFI-25x25**

Dimensions: Ø32x32 mm, Weight: 65 g

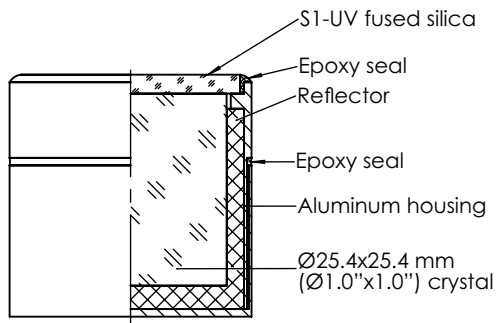

SCALE: 1:1

### Scintillation crystal **SC-25x28**

Dimensions: Ø32x45 mm, Weight: 110 g

### Scintillation crystal **NaI-25x28**

Dimensions: Ø32x45 mm, Weight: 95 g

### Scintillation crystal **CsI-25x28**

Dimensions: Ø32x45 mm, Weight: 110 g

### Scintillation crystal **nFI-25x28**

Dimensions: Ø32x45 mm, Weight: 90 g

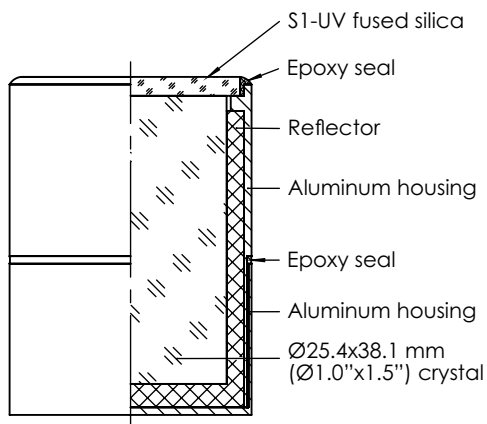

SCALE: 1:1

### Scintillation crystal **SC-38x38 (SC-40x40)**

Dimensions: Ø32x45 mm,  
Weight: 240 g (275 g).

### Scintillation crystal **NaI-38x38 (NaI-40x40)**

Dimensions: Ø32x45 mm,  
Weight: 210 g (230 g).

### Scintillation crystal **CsI-38x38 (CsI-40x40)**

Dimensions: Ø32x45 mm,  
Weight: 240 g (275 g).

### Scintillation crystal **nFI-38x38 (nFI-40x40)**

Dimensions: Ø32x45 mm,  
Weight: 190 g (210 g)

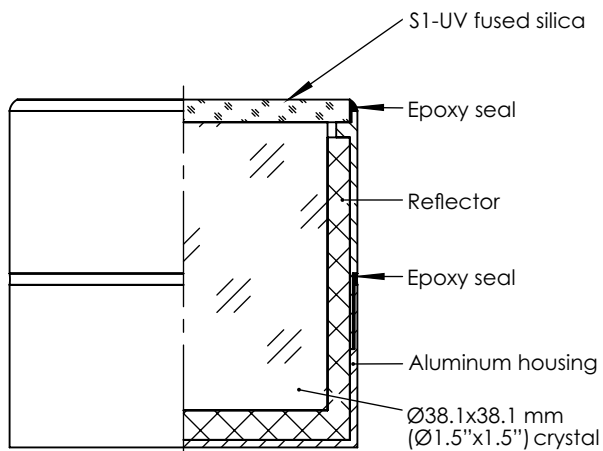

SCALE: 1:1



## Typical Crystals 2D drawings

### Scintillation crystal **SC-51x51**

Dimensions: Ø59x58 mm, Weight: 580 g

### Scintillation crystal **NaI-51x51**

Dimensions: Ø59x58 mm, Weight: 490 g

### Scintillation crystal **CsI-51x51**

Dimensions: Ø59x58 mm, Weight: 580 g

### Scintillation crystal **nEL-51x51**

Dimensions: Ø59x58 mm, Weight: 450 g

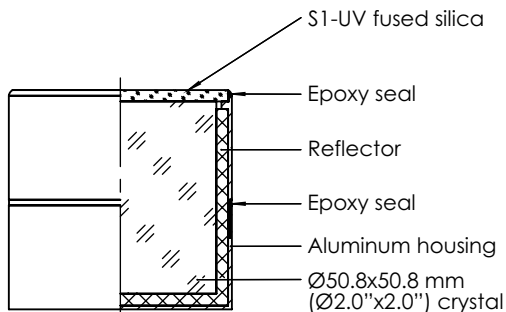

SCALE: 1:2

### Scintillation crystal **nEL-51x102**

Dimensions: Ø59x110 mm, Weight: 900 g

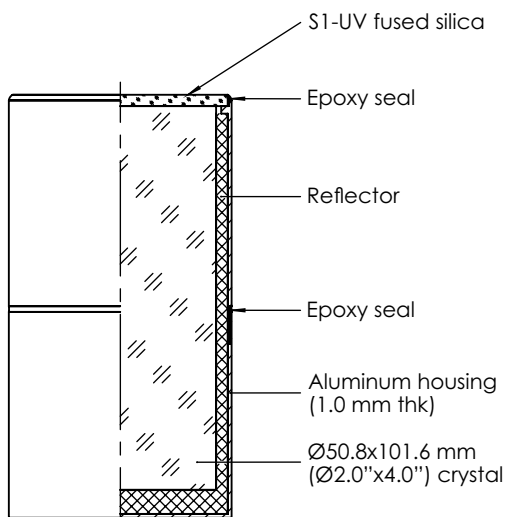

SCALE: 1:2

### Scintillation crystal **SC-63x63-G**

Dimensions: Ø71x72 mm, Weight: 1050 g

### Scintillation crystal **NaI-63x63-G**

Dimensions: Ø71x72 mm, Weight: 840 g

### Scintillation crystal **CsI-63x63-G**

Dimensions: Ø71x72 mm, Weight: 1050 g

### Scintillation crystal **nEL-63x63-G**

Dimensions: Ø71x72 mm, Weight: 780 g

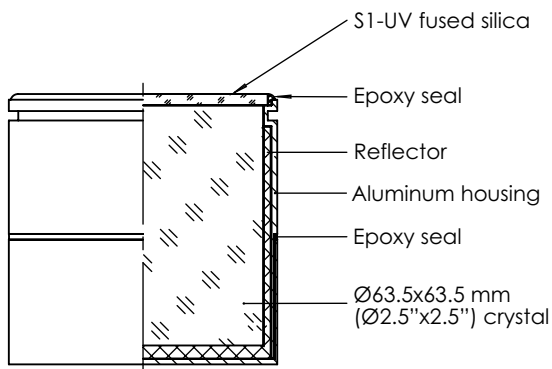

SCALE: 1:2

## Typical Crystals 2D drawings

### Scintillation crystal **SC-76x76**

Dimensions: Ø86x84 mm, Weight: 1750 g

### Scintillation crystal **NaI-76x76**

Dimensions: Ø86x84 mm, Weight: 1450 g

### Scintillation crystal **nEL-76x76**

Dimensions: Ø86x84 mm, Weight: 1300 g

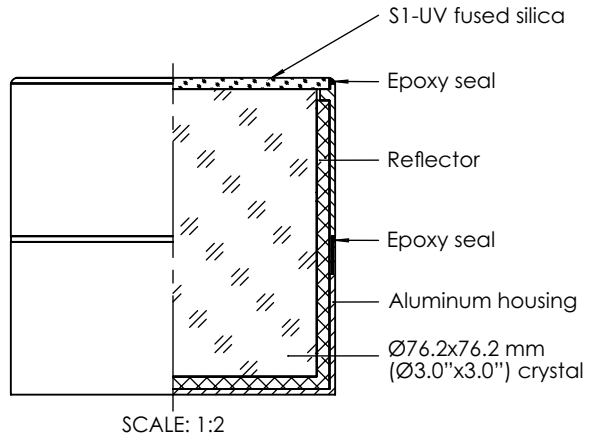



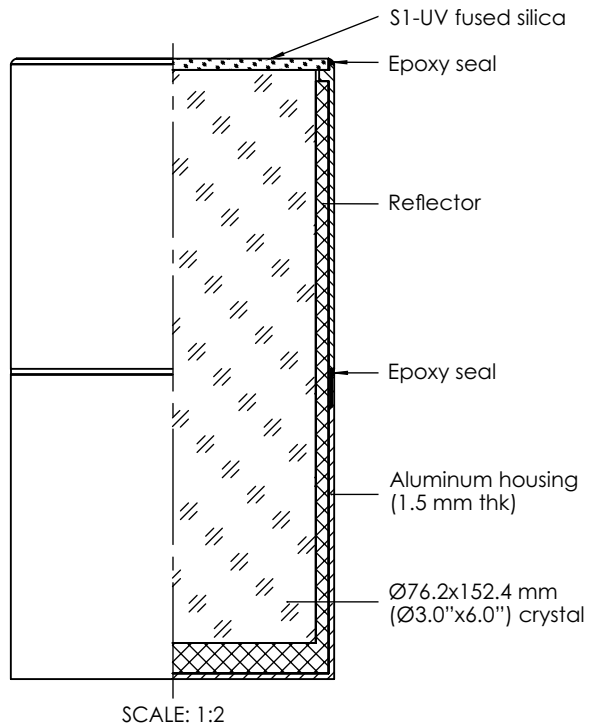

### Scintillation crystal **nEL-76x152**

Dimensions: Ø86x165 mm, Weight: 2800 g

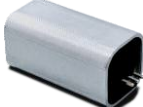





## ScintiClear Detector Assemblies

	SC-6x6c-SiPM	SC-6x13c-SiPM	SC-6x25c-SiPM
Shape	Cuboid	Cuboid	Cuboid
Detector type	SrI <sub>2</sub> (Eu)	SrI <sub>2</sub> (Eu)	SrI <sub>2</sub> (Eu)
Detector size	6x6x6 mm	6x6x13 mm	6x6x25 mm
Energy range	From 10 keV	From 10 keV	From 10 keV
Typical resolution	3% at 662 keV	3% at 662 keV	3% at 662 keV
Typical sensitivity to gamma radiation, cps/( $\mu$ Sv·h <sup>-1</sup> )	5 ( <sup>137</sup> Cs)	10 ( <sup>137</sup> Cs)	20 ( <sup>137</sup> Cs)
Readout	6 mm SiPM	6 mm SiPM	6 mm SiPM
Dimensions	9x9x16 mm	9x9x23 mm	9x9x35 mm
Weight	3 g	5 g	8 g
Additional Information	Fast and standard outputs	Fast and standard outputs	Fast and standard outputs
Image			



	SC-6x50c-SiPM	SC-14x1c-SiPM-T
Shape	Cuboid	Cuboid
Detector type	SrI <sub>2</sub> (Eu)	SrI <sub>2</sub> (Eu)
Detector size	6x6x50 mm	14x14x1 mm
Energy range	From 10 keV	From 2 keV
Typical resolution	3.5% at 662 keV	30% at 5.9 keV
Typical sensitivity to gamma radiation, cps/( $\mu$ Sv·h <sup>-1</sup> )	40 ( <sup>137</sup> Cs)	N/A
Readout	6 mm SiPM	2x2 6mm SiPMs
Dimensions	9x9x60 mm	17x17x18 mm
Weight	15 g	8 g
Additional Information	Fast and standard outputs	0.1mm Be window for low energy X-rays. Fast and standard outputs. Integrated temperature sensor
Image		



## ScintiClear Detector Assemblies

	SC-14x25c-SiPM-T	SC-28x51c-SiPM-T
Shape	Cuboid	Cuboid
Detector type	SrI <sub>2</sub> (Eu)	SrI <sub>2</sub> (Eu)
Detector size	14x14x25.4 mm	28x28x50.8 mm
Energy range	From 10 keV	From 10 keV
Typical resolution	3.0% at 662 keV	3.2% at 662 keV
Typical sensitivity to gamma radiation, cps/( $\mu$ Sv·h <sup>-1</sup> )	130 ( <sup>137</sup> Cs)	780 ( <sup>137</sup> Cs) 600 ( <sup>60</sup> Co)
Readout	2x2 6mm SiPMs	4x4 6mm SiPMs
Dimensions	17x17x32 mm	31x31x64 mm
Weight	26 g	200 g
Additional Information	Fast and standard outputs. Integrated temperature sensor	Fast and standard outputs. Integrated temperature sensor
Image		

	SC-38x25-R6231	SC-38x51-R6231-01
Shape	Cylinder	Cylinder
Detector type	SrI <sub>2</sub> (Eu)	SrI <sub>2</sub> (Eu)
Detector size	Ø38.1x25.4 mm	Ø38.1x50.8 mm
Energy range	From 10 keV	From 10 keV
Typical resolution	3.0% at 662 keV	3.0% at 662 keV
Typical sensitivity to gamma radiation, cps/( $\mu$ Sv·h <sup>-1</sup> )	600 ( <sup>137</sup> Cs) 450 ( <sup>60</sup> Co)	850 ( <sup>137</sup> Cs) 700 ( <sup>60</sup> Co)
Readout	PMT R6231	PMT R6231
Dimensions	Ø60x143 mm	Ø60x169 mm
Weight	470 g	600 g
Additional Information	Encapsulated with magnetic shielding and moisture barrier	Encapsulated with magnetic shielding and moisture barrier
Image		



## ScintiClear Detector Assemblies

	<b>SC-38x38-R6231</b>	<b>SC-38x38-R6231-01</b>
Shape	Cylinder	Cylinder
Detector type	SrI <sub>2</sub> (Eu)	SrI <sub>2</sub> (Eu)
Detector size	Ø38.1x38.1 mm	Ø38.1x38.1 mm
Energy range	From 10 keV	From 10 keV
Typical resolution	3.0% at 662 keV	3.0% at 662 keV
Typical sensitivity to gamma radiation, cps/( $\mu$ Sv·h <sup>-1</sup> )	800 ( <sup>137</sup> Cs) 400 ( <sup>60</sup> Co)	800 ( <sup>137</sup> Cs) 400 ( <sup>60</sup> Co)
Readout	PMT R6231	PMT R6231-01
Dimensions	Ø60x156 mm	Ø60x150 mm
Weight	530 g	530 g
Additional Information	Encapsulated with magnetic shielding and moisture barrier	Encapsulated with magnetic shielding and moisture barrier
Image		

	<b>SC-46x25-R6231</b>	<b>SC-46x46-R6231</b>	<b>SC-46x51-R6231</b>
Shape	Cylinder	Cylinder	Cylinder
Detector type	SrI <sub>2</sub> (Eu)	SrI <sub>2</sub> (Eu)	SrI <sub>2</sub> (Eu)
Detector size	Ø46.0x25.4 mm	Ø46.0x46.0 mm	Ø46.0x50.8 mm
Energy range	From 10 keV	From 10 keV	From 10 keV
Typical resolution	3% at 662 keV	3% at 662 keV	3% at 662 keV
Typical sensitivity to gamma radiation, cps/( $\mu$ Sv·h <sup>-1</sup> )	850 ( <sup>137</sup> Cs) 650 ( <sup>60</sup> Co)	1150 ( <sup>137</sup> Cs) 970 ( <sup>60</sup> Co)	1200 ( <sup>137</sup> Cs) 1010 ( <sup>60</sup> Co)
Readout	PMT R6231	PMT R6231	PMT R6231
Dimensions	Ø60x143 mm	Ø60x164 mm	Ø60x169 mm
Weight	550 g	710 g	750 g
Additional Information	Encapsulated with magnetic shielding and moisture barrier	Encapsulated with magnetic shielding and moisture barrier	Encapsulated with magnetic shielding and moisture barrier
Image			

# Scintillation Assemblies



## ScintiClear Detector Assemblies

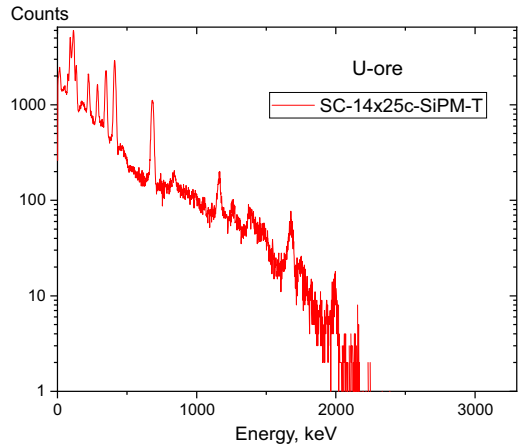
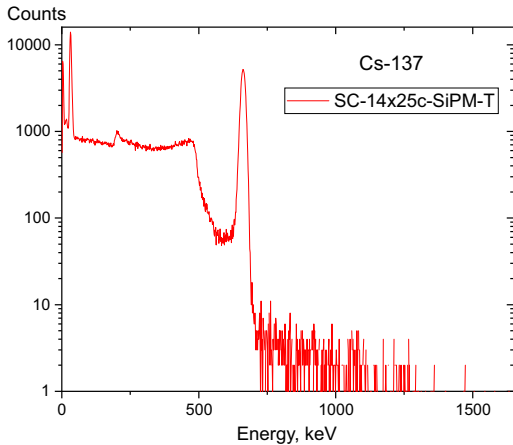
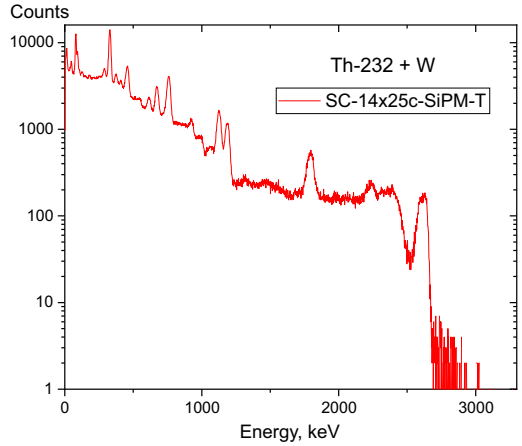
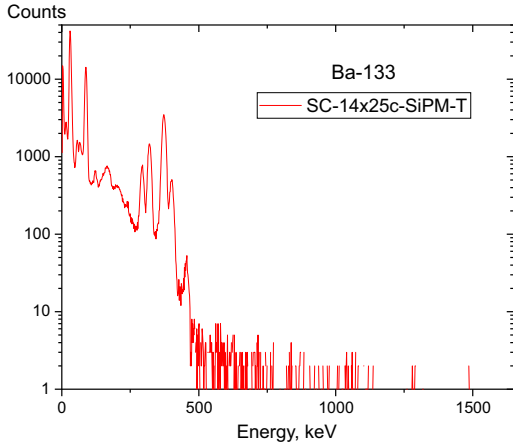
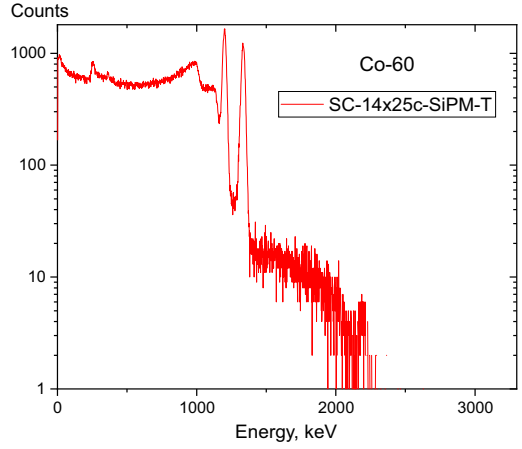
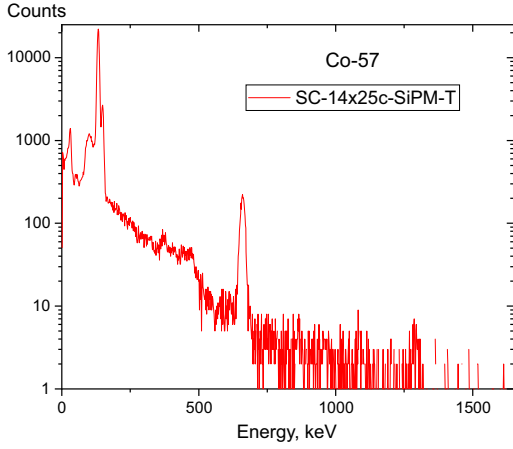

	SC-51x25-R6232	SC-51x38-R6232	SC-51x51-R6232
Shape	Cylinder	Cylinder	Cylinder
Detector type	SrI <sub>2</sub> (Eu)	SrI <sub>2</sub> (Eu)	SrI <sub>2</sub> (Eu)
Detector size	Ø50.8x25.4 mm	Ø50.8x38.1 mm	Ø50.8x50.8 mm
Energy range	From 10 keV	From 10 keV	From 10 keV
Typical resolution	3% at 662 keV	3% at 662 keV	3% at 662 keV
Typical sensitivity to gamma radiation, cps/( $\mu$ Sv·h <sup>-1</sup> )	1050 ( <sup>137</sup> Cs) 800 ( <sup>60</sup> Co)	1300 ( <sup>137</sup> Cs) 1050 ( <sup>60</sup> Co)	1500 ( <sup>137</sup> Cs) 1200 ( <sup>60</sup> Co)
Readout	PMT R6232	PMT R6232	PMT R6232
Dimensions	Ø70x160 mm	Ø70x173 mm	Ø70x190 mm
Weight	570 g	740 g	850 g
Additional Information	Encapsulated with magnetic shielding and moisture barrier	Encapsulated with magnetic shielding and moisture barrier	Encapsulated with magnetic shielding and moisture barrier
Image			

*(All spectra taken with MacroPixel SC-14x25c-SiPM-T detector assembly)*



## Nal(Tl) Detector Assemblies

	Nal-14x25c-SiPM-T	Nal-28x51c-SiPM-T	Nal-38x38-R6231
Shape	Cuboid	Cuboid	Cylinder
Detector type	Nal(Tl)	Nal(Tl)	Nal(Tl)
Detector size	14x14x25.4 mm	28x28x50.8 mm	Ø38.1x38.1 mm
Energy range	From 10 keV	From 10 keV	From 10 keV
Typical resolution	6.5% at 662 keV	6.5% at 662 keV	6.5% at 662 keV
Typical sensitivity to gamma radiation, cps/( $\mu\text{Sv}\cdot\text{h}^{-1}$ )	95 ( $^{137}\text{Cs}$ )	690 ( $^{137}\text{Cs}$ ) 515 ( $^{60}\text{Co}$ )	650 ( $^{137}\text{Cs}$ )
Readout	2x2 6 mm SiPMs	4x4 6 mm SiPMs	PMT R6231
Dimensions	17x17x32 mm	31x31x64 mm	Ø60x156 mm
Weight	25 g	165 g	480 g
Additional Information	Fast and standard outputs. Integrated temperature sensor	Fast and standard outputs. Integrated temperature sensor	Encapsulated with magnetic shielding and moisture barrier
Image			

	Nal-51x51-R6231	Nal-63x63-R6232
Shape	Cylinder	Cylinder
Detector type	Nal(Tl)	Nal(Tl)
Detector size	Ø50.8x50.8 mm	Ø63.5x63.5 mm
Energy range	From 10 keV	From 10 keV
Typical resolution	6.5% at 662 keV	6.5% at 662 keV
Typical sensitivity to gamma radiation, cps/( $\mu\text{Sv}\cdot\text{h}^{-1}$ )	1350 ( $^{137}\text{Cs}$ )	2300 ( $^{137}\text{Cs}$ ) 1970 ( $^{60}\text{Co}$ )
Readout	PMT R6231	PMT R6232
Dimensions	Ø60x167 mm	Ø70x198 mm
Weight	750 g	900 g
Additional Information	Encapsulated with magnetic shielding and moisture barrier	Encapsulated with magnetic shielding and moisture barrier
Image		



# Scintillation Assemblies



## Unambiguous Identification with NaI Scintillation Assemblies

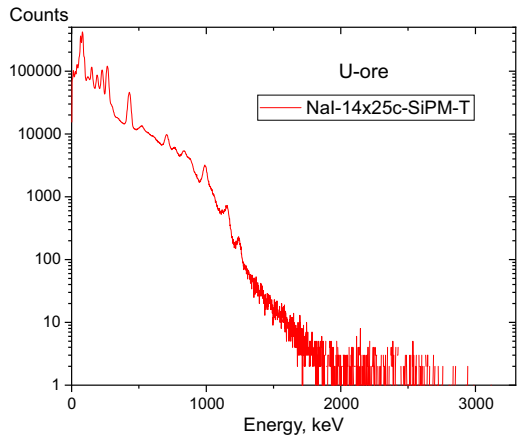
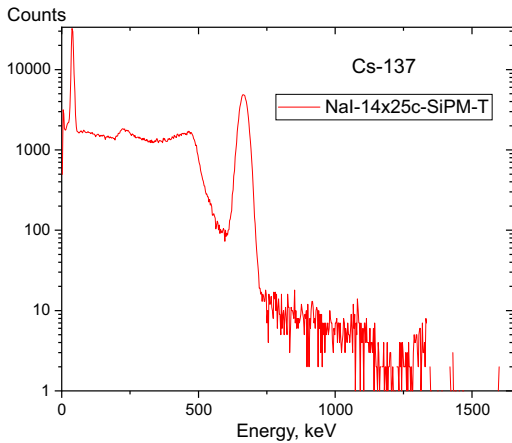
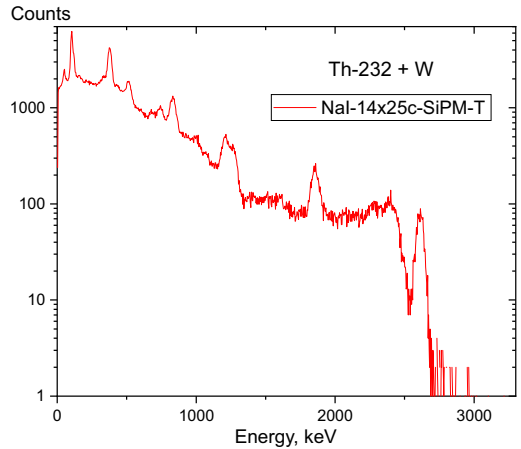
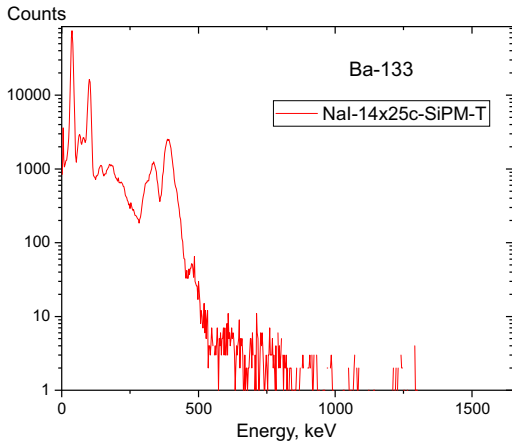
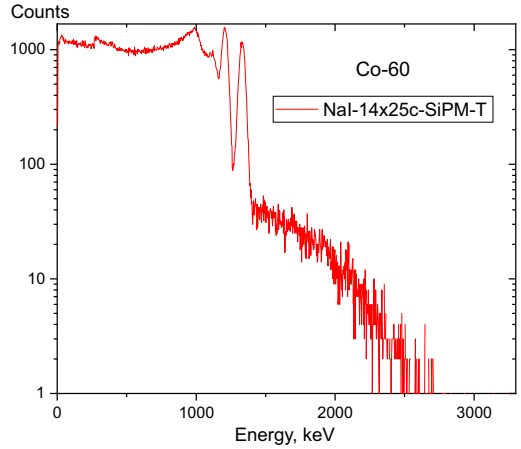
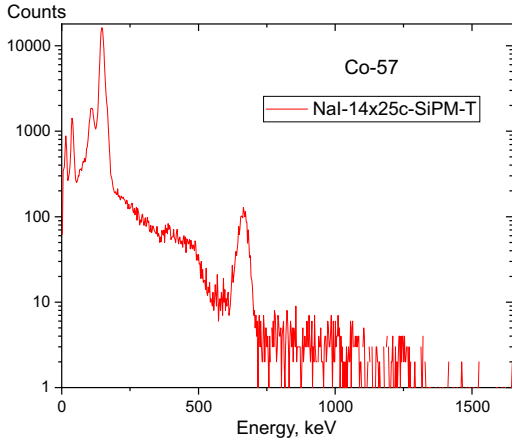

*(All spectra taken with MacroPixel NaI-14x25c-SiPM-T detector assembly)*



# Scintillation Assemblies

## CsI(Tl) Detector Assemblies

	CsI-14x25c-SiPM-T	CsI-28x51c-SiPM-T	CsI-38x38-R6231
Shape	Cuboid	Cuboid	Cylinder
Detector type	CsI(Tl)	CsI(Tl)	CsI(Tl)
Detector size	14x14x25.4 mm	28x28x50.8 mm	Ø38.1x38.1 mm
Energy range	From 10 keV	From 10 keV	From 10 keV
Typical resolution	6% at 662 keV	6% at 662 keV	6% at 662 keV
Typical sensitivity to gamma radiation, cps/( $\mu\text{Sv}\cdot\text{h}^{-1}$ )	120 ( $^{137}\text{Cs}$ )	780 ( $^{137}\text{Cs}$ ) 590 ( $^{60}\text{Co}$ )	800 ( $^{137}\text{Cs}$ ) 400 ( $^{60}\text{Co}$ )
Readout	2x2 6 mm SiPMs	4x4 6 mm SiPMs	PMT R6231
Dimensions	17x17x32 mm	31x3x64 mm	Ø60x156 mm
Weight	32 g	200 g	530 g
Additional Information	Fast and standard outputs. Integrated temperature sensor	Fast and standard outputs. Integrated temperature sensor	Encapsulated with magnetic shielding and moisture barrier
Image			



	CsI-51x51-R6231	CsI-63x63-R6232
Shape	Cylinder	Cylinder
Detector type	CsI(Tl)	CsI(Tl)
Detector size	Ø50.8x50.8 mm	Ø63.5x63.5 mm
Energy range	From 10 keV	From 10 keV
Typical resolution	5.5% at 662 keV	6% at 662 keV
Typical sensitivity to gamma radiation, cps/( $\mu\text{Sv}\cdot\text{h}^{-1}$ )	1500 ( $^{137}\text{Cs}$ ) 1200 ( $^{60}\text{Co}$ )	2500 ( $^{137}\text{Cs}$ ) 2150 ( $^{60}\text{Co}$ )
Readout	PMT R6231	PMT R6232
Dimensions	Ø60x167 mm	Ø70x198 mm
Weight	850 g	1140 g
Additional Information	Encapsulated with magnetic shielding and moisture barrier	Encapsulated with magnetic shielding and moisture barrier
Image		

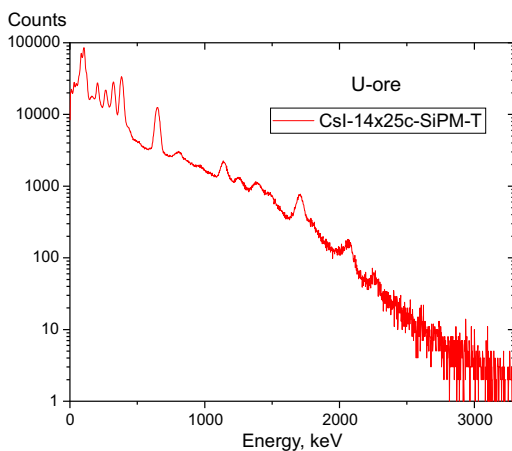
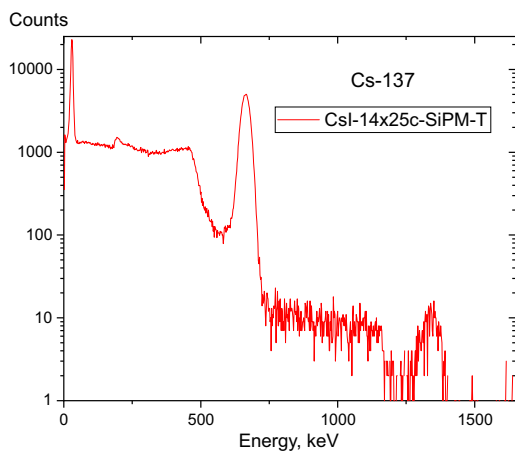
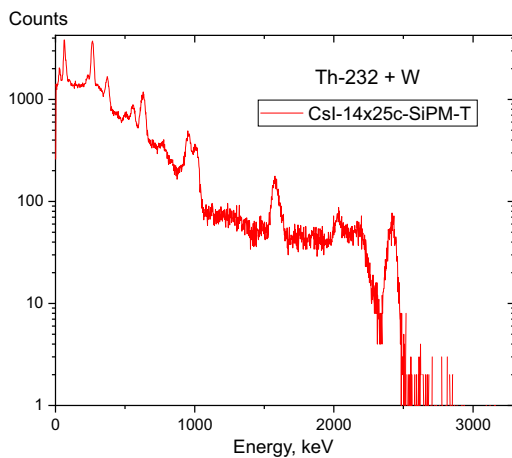
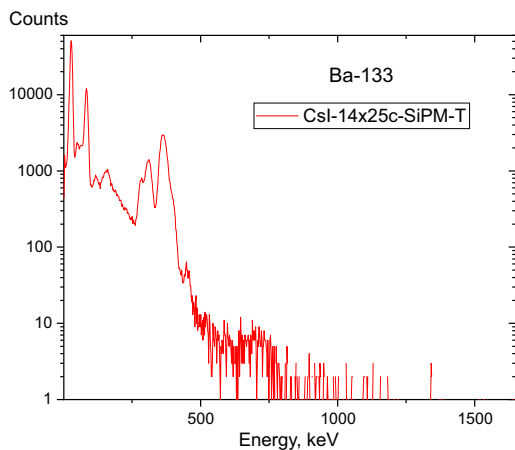
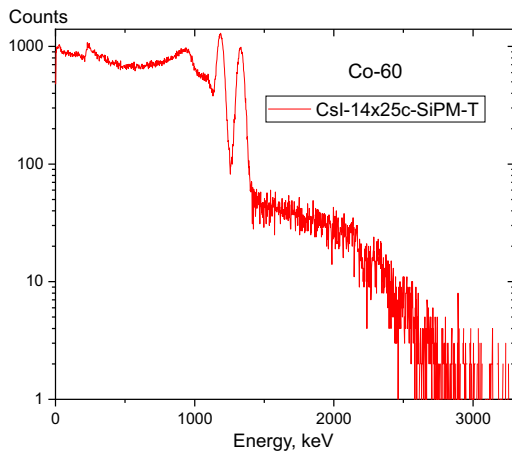
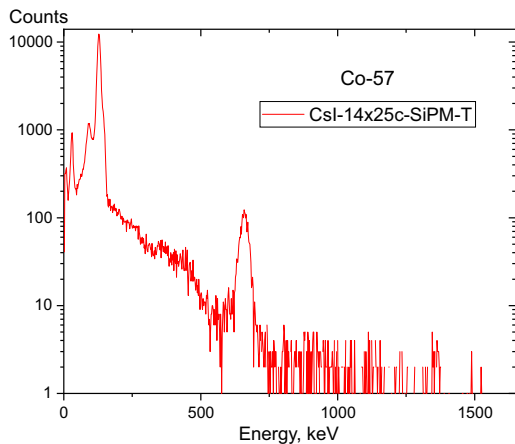

## Unambiguous Identification with CsI Scintillation Assemblies

*(All spectra taken with MacroPixel CsI-14x25c-SiPM-T detector assembly)*





## Elpasolight Detector Assemblies



	nEL-6x6c-SiPM	nEL-6x13c-SiPM	nEL-6x25c-SiPM
Shape	Cuboid	Cuboid	Cuboid
Detector type	Cs <sub>2</sub> LiYCl <sub>6</sub>	Cs <sub>2</sub> LiYCl <sub>6</sub>	Cs <sub>2</sub> LiYCl <sub>6</sub>
Detector size	6x6x6 mm	6x6x12 mm	6x6x25 mm
Energy range	From 10 keV	From 10 keV	From 10 keV
Typical resolution	5% at 662 keV	5% at 662 keV	5% at 662 keV
Typical sensitivity to gamma radiation, cps/( $\mu$ Sv·h <sup>-1</sup> )	4 ( <sup>137</sup> Cs)	8 ( <sup>137</sup> Cs)	16 ( <sup>137</sup> Cs)
Neutron detection	Yes	Yes	Yes
Readout	6 mm SiPM	6 mm SiPM	6 mm SiPM
Dimensions	9x9x16 mm	9x9x23 mm	9x9x35 mm
Weight	3 g	5 g	7 g
Additional Information	Fast and standard outputs	Fast and standard outputs	Fast and standard outputs
Image			

	nEL-6x50c-SiPM	nEL-14x25c-SiPM-T	nEL-28x51c-SiPM-T
Shape	Cuboid	Cuboid	Cuboid
Detector type	Cs <sub>2</sub> LiYCl <sub>6</sub>	Cs <sub>2</sub> LiYCl <sub>6</sub>	Cs <sub>2</sub> LiYCl <sub>6</sub>
Detector size	6x6x50 mm	14x14x25.4 mm	28x28x50.8 mm
Energy range	From 10 keV	From 10 keV	From 20 keV
Typical resolution	5% at 662 keV	4.5% at 662 keV	6% at 662 keV
Typical sensitivity to gamma radiation, cps/( $\mu$ Sv·h <sup>-1</sup> )	32 ( <sup>137</sup> Cs)	90 ( <sup>137</sup> Cs)	635 ( <sup>137</sup> Cs) 480 ( <sup>60</sup> Co)
Neutron detection	Yes	Yes	Yes
Readout	6 mm SiPM	2x2 6 mm SiPMs	4x4 6 mm SiPMs
Dimensions	9x9x60 mm	17x17x32 mm	31x31x64 mm
Weight	13 g	25 g	150 g
Additional Information	Fast and standard outputs	Fast and standard outputs. Integrated temperature sensor	Fast and standard outputs. Integrated temperature sensor
Image			

*Design and specifications are subject to change without notice*

## Elpasolight Detector Assemblies

	nEL-38x25-R6231	nEL-38x38-R6231	nEL-38x51-R6231
Shape	Cylinder	Cylinder	Cylinder
Detector type	Cs <sub>2</sub> LiYCl <sub>6</sub>	Cs <sub>2</sub> LiYCl <sub>6</sub>	Cs <sub>2</sub> LiYCl <sub>6</sub>
Detector size	Ø38.1x25.4 mm	Ø38.1x38.1 mm	Ø38.1x50.8 mm
Energy range	From 10 keV	From 10 keV	From 10 keV
Typical resolution	4% at 662 keV	4% at 662 keV	4% at 662 keV
Typical sensitivity to gamma radiation, cps/( $\mu$ Sv·h <sup>-1</sup> )	470 ( <sup>137</sup> Cs)	600 ( <sup>137</sup> Cs)	730 ( <sup>137</sup> Cs)
Neutron detection	Yes	Yes	Yes
Readout	PMT R6231	PMT R6231	PMT R6231
Dimensions	Ø60x143 mm	Ø60x156 mm	Ø60x169 mm
Weight	450 g	470 g	500 g
Additional Information	Encapsulated with magnetic shielding and moisture barrier	Encapsulated with magnetic shielding and moisture barrier	Encapsulated with magnetic shielding and moisture barrier
Image			

	nEL-51x25-R6232	nEL-51x25-R6231	nEL-51x38-R6231
Shape	Cylinder	Cylinder	Cylinder
Detector type	Cs <sub>2</sub> LiYCl <sub>6</sub>	Cs <sub>2</sub> LiYCl <sub>6</sub>	Cs <sub>2</sub> LiYCl <sub>6</sub>
Detector size	Ø50.8x25.4 mm	Ø50.8x25.4 mm	Ø50.8x38.1 mm
Energy range	From 10 keV	From 10 keV	From 10 keV
Typical resolution	4% at 662 keV	4% at 662 keV	4% at 662 keV
Typical sensitivity to gamma radiation, cps/( $\mu$ Sv·h <sup>-1</sup> )	850 ( <sup>137</sup> Cs)	850 ( <sup>137</sup> Cs) 630 ( <sup>60</sup> Co)	1100 ( <sup>137</sup> Cs) 860 ( <sup>60</sup> Co)
Neutron detection	Yes	Yes	Yes
Readout	PMT R6232	PMT R6231	PMT R6231
Dimensions	Ø70x160 mm	Ø60x141 mm	Ø60x154 mm
Weight	500 g	620 g	650 g
Additional Information	Encapsulated with magnetic shielding and moisture barrier	Encapsulated with magnetic shielding and moisture barrier	Encapsulated with magnetic shielding and moisture barrier
Image			

## ElpasOLight Detector Assemblies

	nEL-51x51-R6231	nEL-51x102-R6231	nEL-63x63-R6232
Shape	Cylinder	Cylinder	Cylinder
Detector type	Cs <sub>2</sub> LiYCl <sub>6</sub>	Cs <sub>2</sub> LiYCl <sub>6</sub>	Cs <sub>2</sub> LiYCl <sub>6</sub>
Detector size	Ø50.8x50.8 mm	Ø50.8x101.6 mm	Ø63.5x63.5 mm
Energy range	From 10 keV	From 10 keV	From 10 keV
Typical resolution	4.5% at 662 keV	4.5% at 662 keV	4.5% at 662 keV
Typical sensitivity to gamma radiation, cps/( $\mu$ Sv·h <sup>-1</sup> )	1300 ( <sup>137</sup> Cs)	2600 ( <sup>137</sup> Cs) 2100 ( <sup>60</sup> Co)	2200 ( <sup>137</sup> Cs) 1870 ( <sup>60</sup> Co)
Neutron detection	Yes	Yes	Yes
Readout	PMT R6231	PMT R6231	PMT R6232
Dimensions	Ø60x167 mm	Ø60x218 mm	Ø70x198 mm
Weight	700g	870 g	880 g
Additional Information	Encapsulated with magnetic shielding and moisture barrier	Encapsulated with magnetic shielding and moisture barrier	Encapsulated with magnetic shielding and moisture barrier
Image			

# Scintillation Assemblies

## Unambiguous Identification with Elpasolight Scintillation Assemblies

*(All spectra taken with MacroPixel nEL-14x25c-SiPM-T detector assembly)*

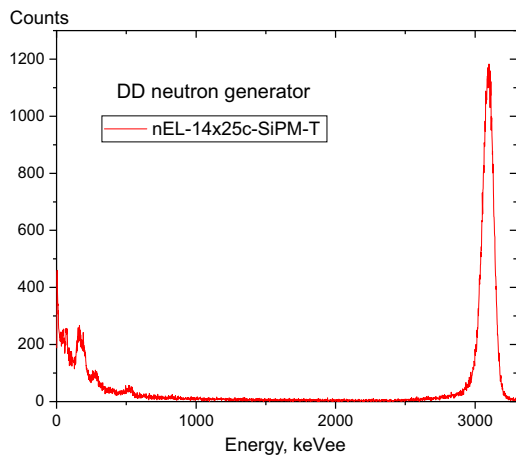
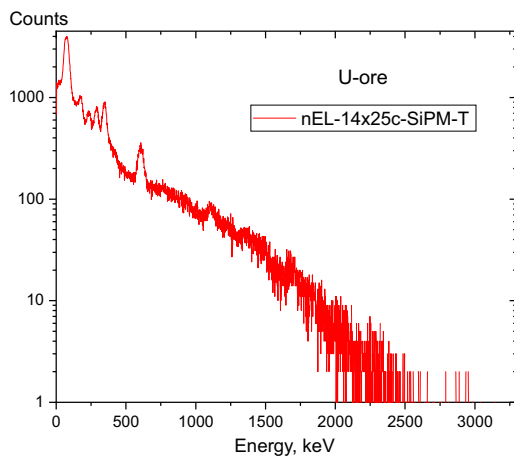
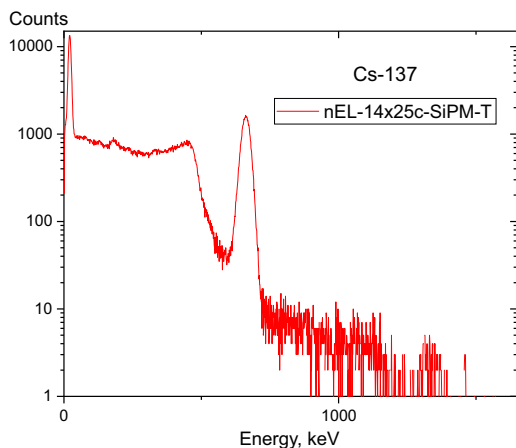
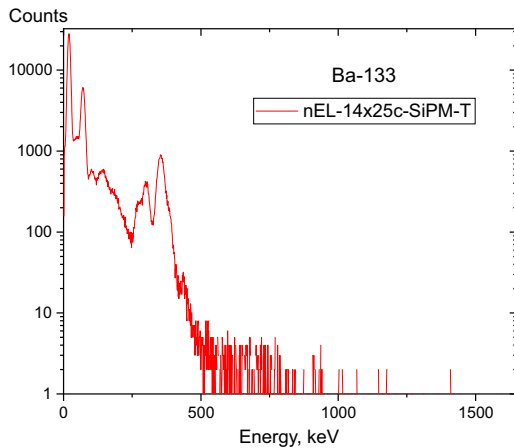
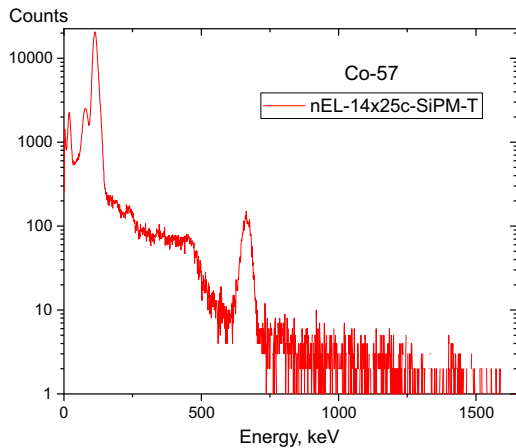

## Typical Detector Assemblies 2D drawings

### ScintiClear SC-6x6c-SiPM

Dimensions: 9x9x16 mm, Weight: 3 g

### Elpasolight nEL-6x6c-SiPM

Dimensions: 9x9x16 mm, Weight: 3 g

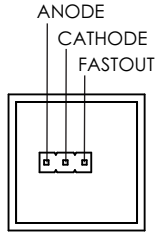
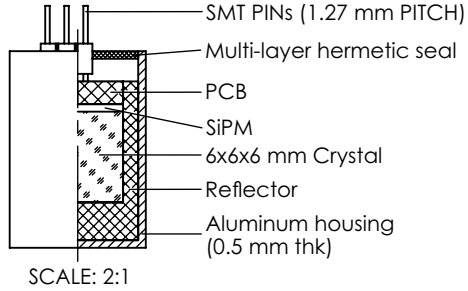

### ScintiClear SC-6x13c-SiPM

Dimensions: 9x9x23 mm, Weight: 5 g

### Elpasolight nEL-6x13c-SiPM

Dimensions: 9x9x23 mm, Weight: 5 g

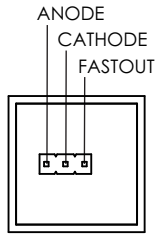
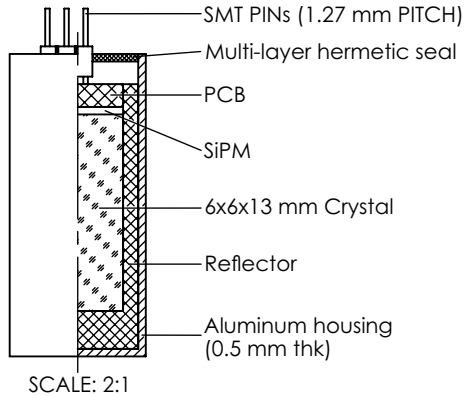

### ScintiClear SC-6x25c-SiPM

Dimensions: 9x9x35 mm, Weight: 8 g

### Elpasolight nEL-6x25c-SiPM

Dimensions: 9x9x35 mm, Weight: 7 g

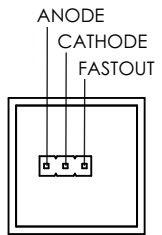
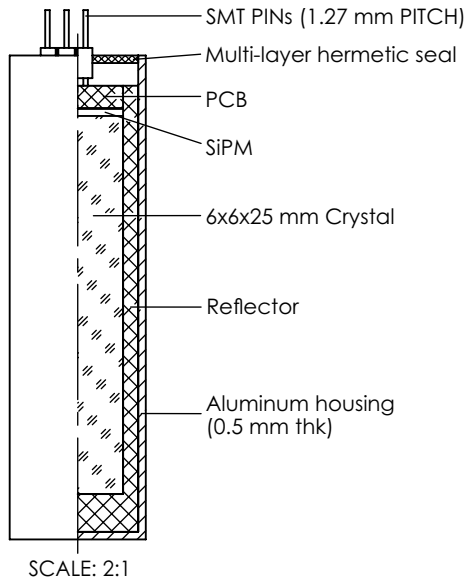



## Typical Detector Assemblies 2D drawings

### ScintiClear SC-6x50c-SiPM

Dimensions: 9x9x60 mm, Weight: 15 g

### Elpasolight nEL-6x50c-SiPM

Dimensions: 9x9x16 mm, Weight: 13 g

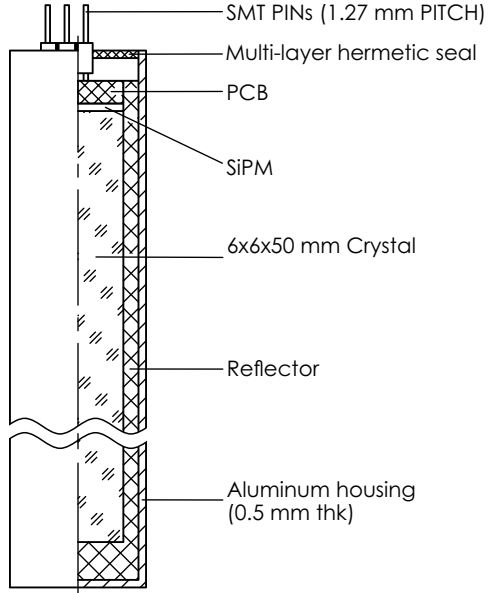
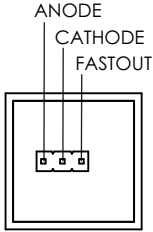

SCALE: 2:1

### MacroPixel SC-14x25c-SiPM-T

Dimensions: 17x17x32 mm, Weight: 26 g

### MacroPixel nEL-14x25c-SiPM-T

Dimensions: 17x17x32 mm, Weight: 25 g

### MacroPixel NaI-14x25c-SiPM-T

Dimensions: 17x17x32 mm, Weight: 25 g

### MacroPixel CsI-14x25c-SiPM-T

Dimensions: 17x17x32 mm, Weight: 32 g

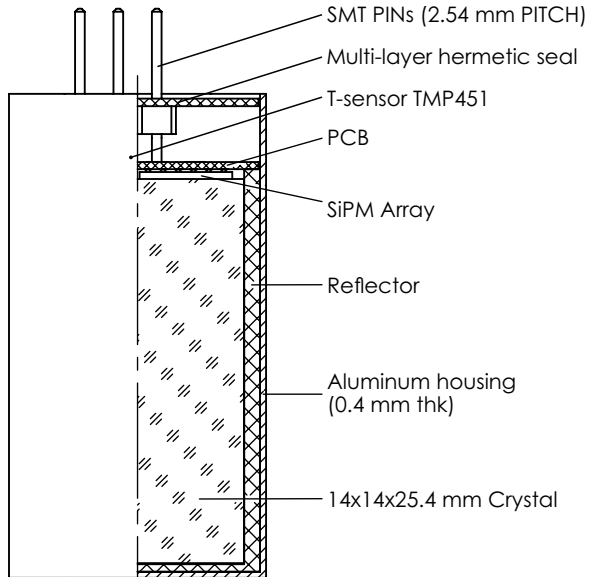
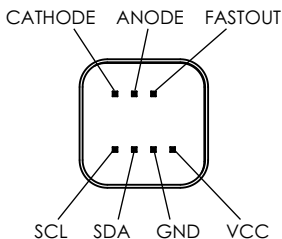

SCALE: 2:1

### ScintiClear SC-14x1c-SiPM-T

Dimensions: 17x17x18 mm, Weight: 8 g

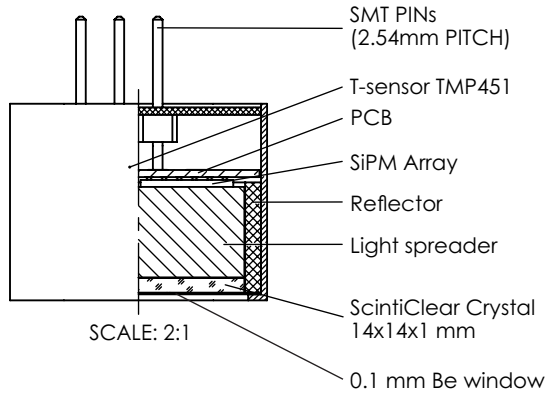
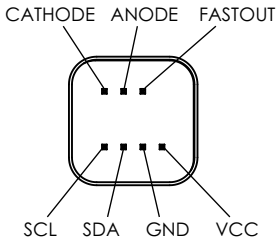

### MegaPixel SC-28x51c-SiPM-T

Dimensions: 31x31x64 mm, Weight: 200 g

### MegaPixel nEL-28x51c-SiPM-T

Dimensions: 31x31x64 mm, Weight: 150 g

### MegaPixel NaI-28x51c-SiPM-T

Dimensions: 31x31x64 mm, Weight: 165 g

### MegaPixel CsI-28x51c-SiPM-T

Dimensions: 31x31x64 mm, Weight: 200 g

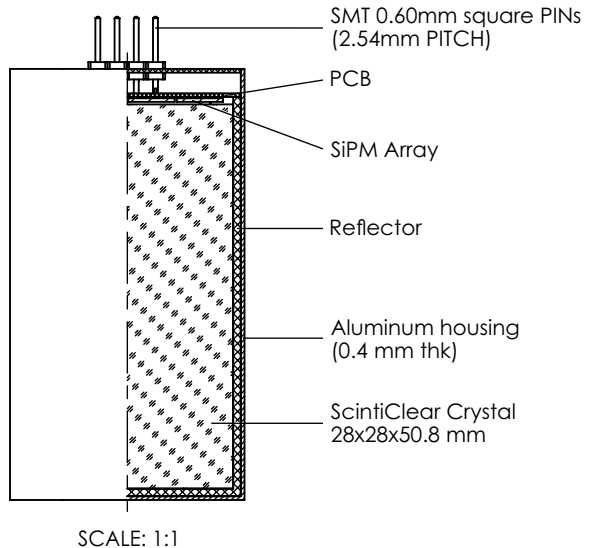
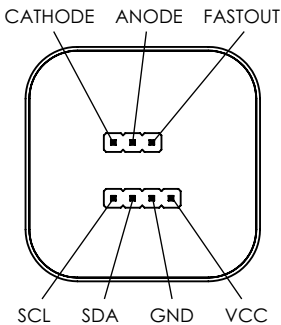

### ScintiClear SC-38x38-R6231

Dimensions: Ø60x156 mm, Weight: 530 g

### Elpasolight nEL-38x38-R6231

Dimensions: Ø60x156 mm, Weight: 470 g

### Detector Assembly NaI-38x38-R6231

Dimensions: Ø60x156 mm, Weight: 480 g

### Detector Assembly CsI-38x38-R6231

Dimensions: Ø60x156 mm, Weight: 530 g

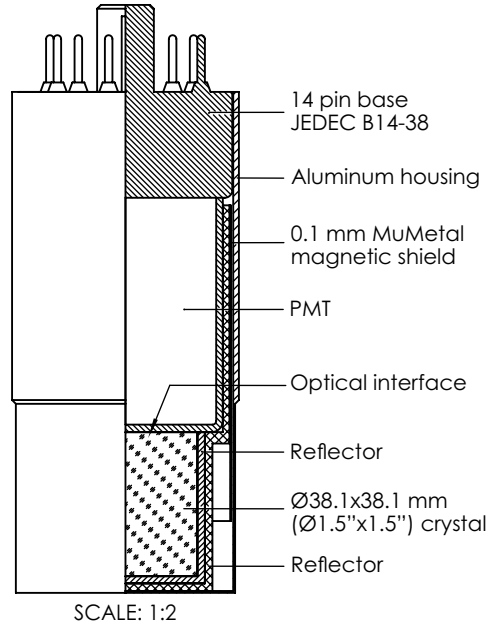
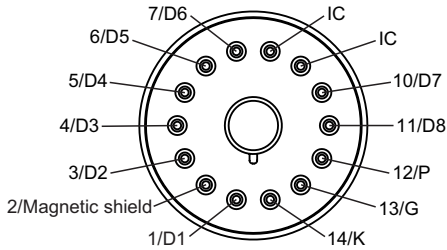

### ScintiClear SC-38x38-R6231-01

Dimensions: Ø60x150 mm, Weight: 530 g

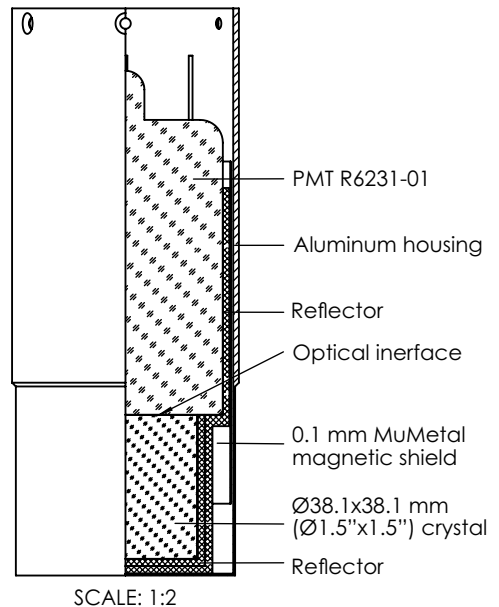
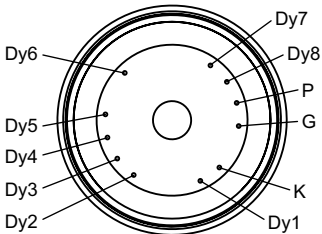

### ScintiClear SC-46x46-R6231

Dimensions:  $\varnothing 60 \times 164$  mm, Weight: 710 g

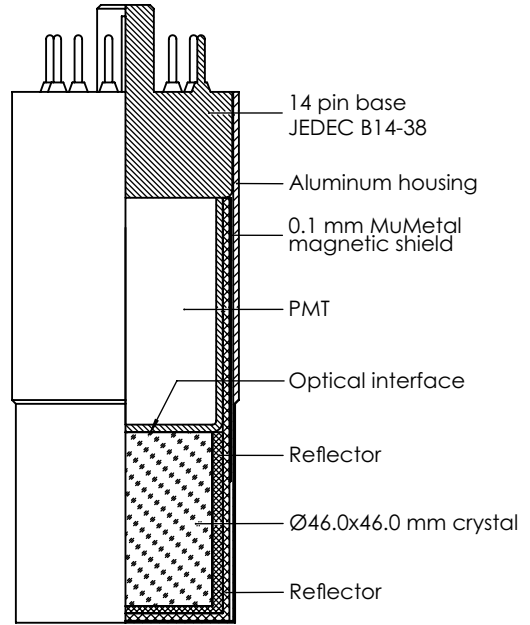
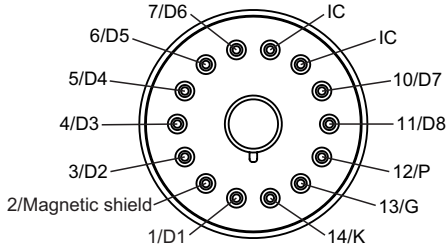

SCALE: 1:2

### ScintiClear SC-51x25-R6232

Dimensions:  $\varnothing 70 \times 160$  mm, Weight: 570 g

### Elpasolight nEL-51x25-R6232

Dimensions:  $\varnothing 70 \times 160$  mm, Weight: 500 g

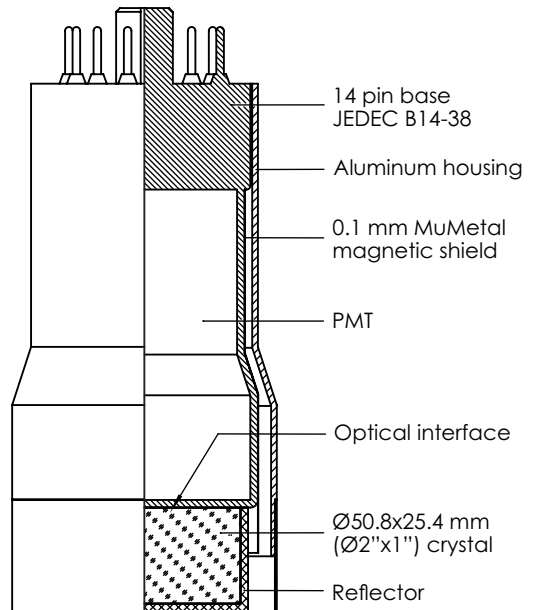
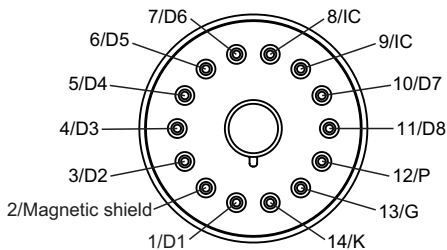

SCALE: 1:2

### Elpasolight nEL-51x51-R6231

Dimensions: Ø60x167 mm, Weight: 700 g

### Detector Assembly NaI-51x51-R6231

Dimensions: Ø60x167 mm, Weight: 750 g

### Detector Assembly CsI-51x51-R6231

Dimensions: Ø60x167 mm, Weight: 850 g

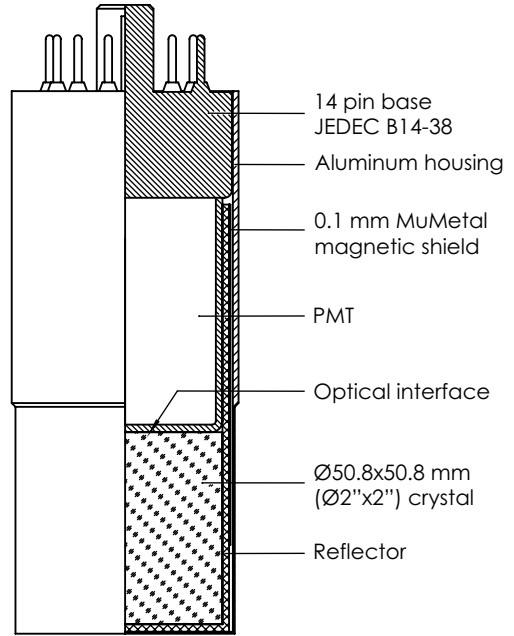
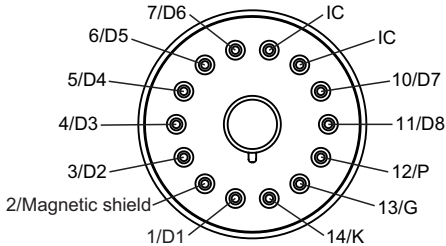

SCALE: 1:2

### Elpasolight nEL-51x102-R6231

Dimensions: Ø60x218 mm, Weight: 870 g

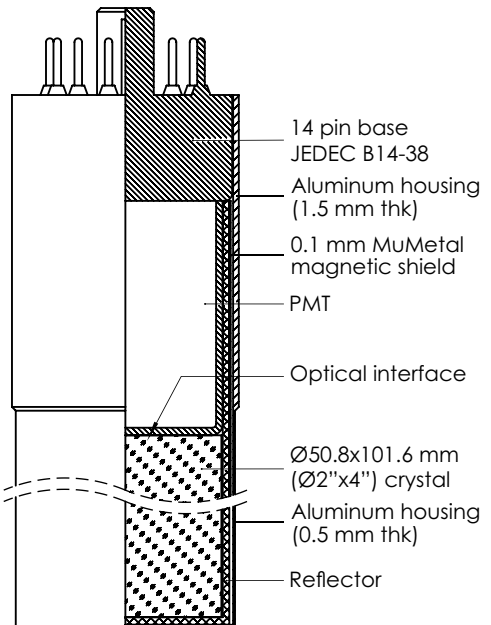
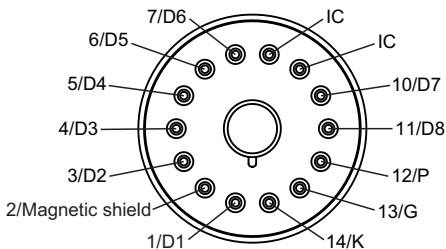

SCALE: 1:2

### Elpasolight nEL-63x36-R6232

Dimensions: Ø70x198 mm, Weight: 880 g

### Detector Assembly NaI-63x36-R6232

Dimensions: Ø70x198 mm, Weight: 900 g

### Detector Assembly CsI-63x63-R6232

Dimensions: Ø70x198 mm, Weight: 1500 g

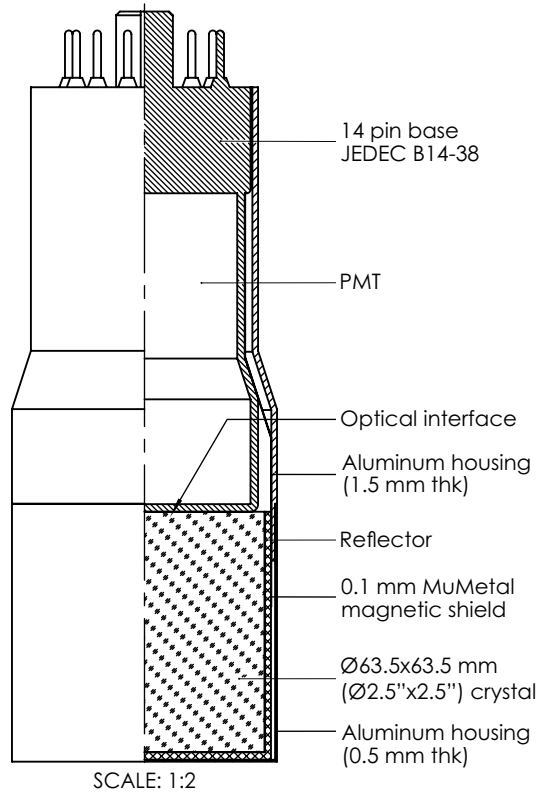
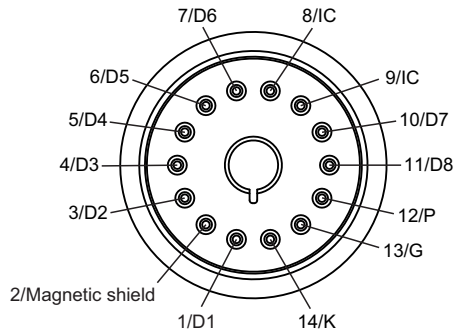

## MacroPixel-MCA Spectrometric Gamma and Gamma Neutron Radiation Probes

Ultra-lightweight and compact **MacroPixel-MCA** Scintillation Gamma and Gamma Neutron Radiation Detection Probes with 14x14x25.4 mm (5 cc) high-performance crystal coupled to SiPM array and read by tiny USB MCA. High sensitive sensor with on the chip temperature stabilization and pulse pile-up rejection, as well as rugged watertight IP67 housing, makes MacroPixel-MCA perfectly suited for field or lab applications. A user-friendly GUI for Windows and Android devices is included with the detector.

- High sensitivity – 5 cc scintillator
- Ultra compact design
- Fully solid state detector not sensitive to magnetic field
- IP67 dust proof and water resistant
- Operating temperature: -40 to 50°C
- Temperature stabilization and pulse pile-up rejection



	SC-MacroPixel-MCA	nEL-MacroPixel-MCA	NaI-MacroPixel-MCA	CsI-MacroPixel-MCA
Detector type	SrI <sub>2</sub> (Eu)	Cs <sub>2</sub> LiYCl <sub>6</sub>	NaI(Tl)	CsI(Tl)
Detector size	14x14x25.4 mm			
Energy range	10 – 4000 keV	20 – 4000 keV	10 – 4000 keV	
Maximum count rate, cps	25000	20000	50000	40000
Typical resolution at 662 keV ( <sup>137</sup> Cs)	3.0%	6.0%	6.5%	6.0%
Typical sensitivity to gamma radiation, cps/(μSv·h <sup>-1</sup> )	130 ( <sup>137</sup> Cs)	90 ( <sup>137</sup> Cs)	95 ( <sup>137</sup> Cs)	120 ( <sup>137</sup> Cs)
Neutron detection	No	Yes	No	
Protection class	IP67			
Interface	Micro USB Type B			
Operation temperature	-40°C to +50°C			
Dimensions	17x17x70 mm			
Weight	40 g	35 g	35 g	40 g

## MegaPixel-MCA Spectrometric Gamma and Gamma Neutron Radiation Probes

Ultra-lightweight and compact **MegaPixel-MCA** Scintillation Gamma and Gamma Neutron Radiation Detection Probes with 28x28x50.8 mm (40 cc) high-performance crystal coupled to SiPM array and read by tiny USB MCA. High sensitive sensor with on the chip temperature stabilization and pulse pile-up rejection, as well as rugged watertight IP67 housing, makes MegaPixel-MCA perfectly suited for field or lab applications. A user-friendly GUI for Windows and Android devices is included with the detector.

- High sensitivity – 40 cc scintillator
- Ultra compact design
- Fully solid state detector not sensitive to magnetic field
- IP67 dust proof and water resistant
- Operating temperature: -20 to 50°C
- Temperature stabilization and pulse pile-up rejection



	SC-MegaPixel-MCA	nEL-MegaPixel-MCA	Nal-MegaPixel-MCA	CsI-MegaPixel-MCA
Detector type	SrI <sub>2</sub> (Eu)	Cs <sub>2</sub> LiYCl <sub>6</sub>	Nal(Tl)	CsI(Tl)
Detector size	28x28x50.8 mm			
Energy range	10 – 4000 keV	20 – 4000 keV	10 – 4000 keV	
Maximum count rate, cps	25000	20000	50000	40000
Typical resolution at 662 keV ( <sup>137</sup> Cs)	3.2%	6.0%V	6.5%	6.0%
Typical sensitivity to gamma radiation, cps/(μSv·h <sup>-1</sup> )	780 ( <sup>137</sup> Cs) 600 ( <sup>60</sup> Co)	635 ( <sup>137</sup> Cs) 480 ( <sup>60</sup> Co)	690 ( <sup>137</sup> Cs) 515 ( <sup>60</sup> Co)	780 ( <sup>137</sup> Cs) 590 ( <sup>60</sup> Co)
Neutron detection	No	Yes	No	
Protection class	IP67			
Interface	Micro USB Type B			
Operation temperature	-20°C to +50°C			
Dimensions	31x31x95 mm			
Weight	210 g	160 g	175 g	210 g



## BDKG-05S Spectrometric Gamma Radiation Probe

**BDKG-05S** Scintillation Gamma Radiation Probe includes SC-38.1×38.1 (ScintiClear Ø1.5"×1.5") detector assembly with LED temperature stabilization, digital MCA, and RS232/RS485/USB communication interface.

BDKG-05S offers about 3% energy resolution at 662 keV and can be used as part of stationary and mobile equipment and robotic devices.

High energy resolution in the entire energy range from 20 keV to multiple MeV and state-of-the-art electronics make it possible to quickly identify complex mixtures of gamma emitting radionuclides.





- Excellent energy resolution – 6% at 122 keV, 3% at 662 keV and 2% at 1333 keV
- High sensitivity ScintiClear (SrI<sub>2</sub>(Eu)) scintillator
- IP67 dust proof and water resistant
- Operating temperature: -20 to 50°C
- LED Temperature stabilization

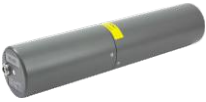

	<b>BDKG-05S</b>
Detector type / size	SrI <sub>2</sub> (Eu) / Ø38x38 mm
Energy range	20 keV – 3 MeV
Typical resolution	3.2% at 662 keV
Measurement range of ambient dose equivalent rate	30 nSv/h – 150 µSv/h
Limits of tolerable intrinsic relative error	±15%
Typical sensitivity to gamma radiation, cps/(µSv·h <sup>-1</sup> )	5500 ( <sup>241</sup> Am) 850 ( <sup>137</sup> Cs) 450 ( <sup>60</sup> Co)
Energy dependence relative to 662 keV ( <sup>137</sup> Cs)	±20% (50 keV – 3 MeV)
Protection class	IP67
Interface	USB / RS232 / RS485 / Bluetooth (Interface adapter)
Operation temperature range	-20...+50°C
Dimensions / weight	Ø60x282 mm / 0.9 kg
Image	



## Spectrometric Gamma Radiation Probes

	<b>BDKG-05S</b>	<b>BDKG-05M</b>
Detector type / size	SrI <sub>2</sub> (Eu) / Ø38x38 mm	NaI(Tl) / Ø40x40 mm
Energy range	20 keV – 3 MeV	20 keV – 3 MeV
Typical resolution	3.2% at 662 keV	7.5% at 662 keV
Measurement range of ambient dose equivalent rate	30 nSv/h – 150 µSv/h	30 nSv/h – 300 µSv/h
Limits of tolerable intrinsic relative error	±15%	±20%
Typical sensitivity to gamma radiation, cps/(µSv·h <sup>-1</sup> )	5500 ( <sup>241</sup> Am) 850 ( <sup>137</sup> Cs) 450 ( <sup>60</sup> Co)	5400 ( <sup>241</sup> Am) 800 ( <sup>137</sup> Cs) 420 ( <sup>60</sup> Co)
Energy dependence relative to 662 keV ( <sup>137</sup> Cs)	±20% (50 keV – 3 MeV)	±15% (50 keV – 3 MeV)
Protection class	IP67	IP54
Interface	USB / RS232 / RS485 / Bluetooth (Interface adapter)	
Operation temperature range	-20...+50°C	
Dimensions / weight	Ø60x282 mm / 0.9 kg	Ø60x291 mm / 0.9 kg
Image		

	<b>BDKG-11M</b>	<b>BDKG-19M</b>
Detector type / size	NaI(Tl) / Ø63x63 mm	NaI(Tl) / Ø63x160 mm
Energy range	20 keV – 3 MeV	20 keV – 3 MeV
Typical resolution	7.5% at 662 keV	8% at 662 keV
Measurement range of ambient dose equivalent rate	30 nSv/h – 150 µSv/h	30 nSv/h – 50 µSv/h
Limits of tolerable intrinsic relative error	±20%	±20%
Typical sensitivity to gamma radiation, cps/(µSv·h <sup>-1</sup> )	13500 ( <sup>241</sup> Am) 2200 ( <sup>137</sup> Cs) 1200 ( <sup>60</sup> Co)	37000 ( <sup>241</sup> Am) 6000 ( <sup>137</sup> Cs) 2500 ( <sup>60</sup> Co)
Energy dependence relative to 662 keV ( <sup>137</sup> Cs)	±15% (50 keV – 3 MeV)	±15% (50 keV – 3 MeV)
Protection class	IP54	IP54
Interface	USB / RS232 / RS485 / Bluetooth (Interface adapter)	
Operation temperature range	-20...+50°C	
Dimensions / weight	Ø76x315 mm / 1.7 kg	Ø76x425 mm / 3 kg
Image		



## Spectrometric Gamma Radiation Probes

	<b>BDKG-201M</b>	<b>BDKG-203M</b>	<b>BDKG-205M</b>
Detector type / size	Nal(Tl) / Ø25x16 mm	Nal(Tl) / Ø25x40 mm	Nal(Tl) / Ø40x40 mm
Energy range	20 keV – 3 MeV	20 keV – 3 MeV	20 keV – 3 MeV
Typical resolution	8.5% at 662 keV	8% at 662 keV	7.5% at 662 keV
Measurement range of ambient dose equivalent rate	50 nSv/h – 1 mSv/h	30 nSv/h – 500 µSv/h	30 nSv/h – 300 µSv/h
Limits of tolerable intrinsic relative error	±20%	±20%	±20%
Typical sensitivity to gamma radiation, cps/(µSv·h <sup>-1</sup> )	1400 ( <sup>241</sup> Am) 165 ( <sup>137</sup> Cs) 80 ( <sup>60</sup> Co)	3600 ( <sup>241</sup> Am) 400 ( <sup>137</sup> Cs) 190 ( <sup>60</sup> Co)	5400 ( <sup>241</sup> Am) 800 ( <sup>137</sup> Cs) 420 ( <sup>60</sup> Co)
Energy dependence relative to 662 keV ( <sup>137</sup> Cs)	±15% (50 keV - 3 MeV)	±15% (50 keV - 3 MeV)	±15% (50 keV - 3 MeV)
Protection class	IP68 (Fresh water measurement at depths up to 50 m. Holds hydrostatic pressure up to 5 atm or 0.6 MPa)		
Interface	USB / RS232 / RS485 / Bluetooth (Interface adapter)		
Operation temperature range	-35...+55°C	-35...+55°C	-35...+55°C
Dimensions / weight	Ø63x285 mm / 1 kg	Ø63x310 mm / 1 kg	Ø63x310 mm / 1 kg
Image			

	<b>BDKG-211M</b>	<b>BDKG-219M</b>
Detector type / size	Nal(Tl) / Ø63x63 mm	Nal(Tl) / Ø63x160 mm
Energy range	20 keV – 3 MeV	20 keV – 3 MeV
Typical resolution	7.5% at 662 keV	8% at 662 keV
Measurement range of ambient dose equivalent rate	30 nSv/h – 120 µSv/h	30 nSv/h – 50 µSv/h
Limits of tolerable intrinsic relative error	±20%	±20%
Typical sensitivity to gamma radiation, cps/(µSv·h <sup>-1</sup> )	13900 ( <sup>241</sup> Am) 2450 ( <sup>137</sup> Cs) 1300 ( <sup>60</sup> Co)	37000 ( <sup>241</sup> Am) 6000 ( <sup>137</sup> Cs) 2500 ( <sup>60</sup> Co)
Energy dependence relative to 662 keV ( <sup>137</sup> Cs)	±15% (50 keV - 3 MeV)	±15% (50 keV - 3 MeV)
Protection class	IP68 (Fresh water measurement at depths up to 50 m. Holds hydrostatic pressure up to 5 atm or 0.6 MPa)	
Interface	USB / RS232 / RS485 / Bluetooth (Interface adapter)	
Operation temperature range	-35...+55°C	-35...+55°C
Dimensions / weight	Ø90x355 mm / 2 kg	Ø90x430 mm / 3.3 kg
Image		

Design and specifications are subject to change without notice

## High Sensitivity Spectrometric Gamma Radiation Probes

	<b>BDKG-28</b>	<b>BDKG-34</b>
Detector type / size	Nal(Tl) / 100x100x400 mm	Nal(Tl) 50x100x400 mm
Energy range	50 keV – 3 MeV	50 keV – 3 MeV
Typical resolution	8.5% at 662 keV	8.5% at 662 keV
Measurement range of ambient dose equivalent rate	0.03 – 7 $\mu\text{Sv/h}$	0.03 – 10 $\mu\text{Sv/h}$
Limits of tolerable intrinsic relative error	$\pm 20\%$	$\pm 20\%$
Typical sensitivity to gamma radiation, cps/ $(\mu\text{Sv}\cdot\text{h}^{-1})$	130000 ( $^{241}\text{Am}$ ) 33000 ( $^{137}\text{Cs}$ ) 19000 ( $^{60}\text{Co}$ )	118000 ( $^{241}\text{Am}$ ) 26500 ( $^{137}\text{Cs}$ ) 15500 ( $^{60}\text{Co}$ )
Energy dependence relative to 662 keV ( $^{137}\text{Cs}$ )	$\pm 20\%$ (50 keV – 3 MeV)	$\pm 20\%$ (50 keV – 3 MeV)
Protection class	IP54	IP54
Interface	USB / RS232 / RS485 / Bluetooth (Interface adapter)	
Operation temperature range	-20...+50°C	-20...+50°C
Dimensions / weight	108x108x710 mm / 19 kg	92x143x682 mm / 10 kg
Image		

Standard and Custom Radiation Detectors

**CapeScint**<sup>TM</sup>

CapeScint, Inc. 6 Huron Dr. Suite 1B  
Natick, MA 01760 | +1 (508) 653-7100  
[www.capescent.com](http://www.capescent.com) | [sales@capecent.com](mailto:sales@capecent.com)